

**A P P L I C A T I O N & I N S T A L L A T I O N
G U I D E L I N E S**

Rayvoss®

Stand-Alone Surge Protection Devices Featuring

Strikesorb®

Surge Suppression Modules

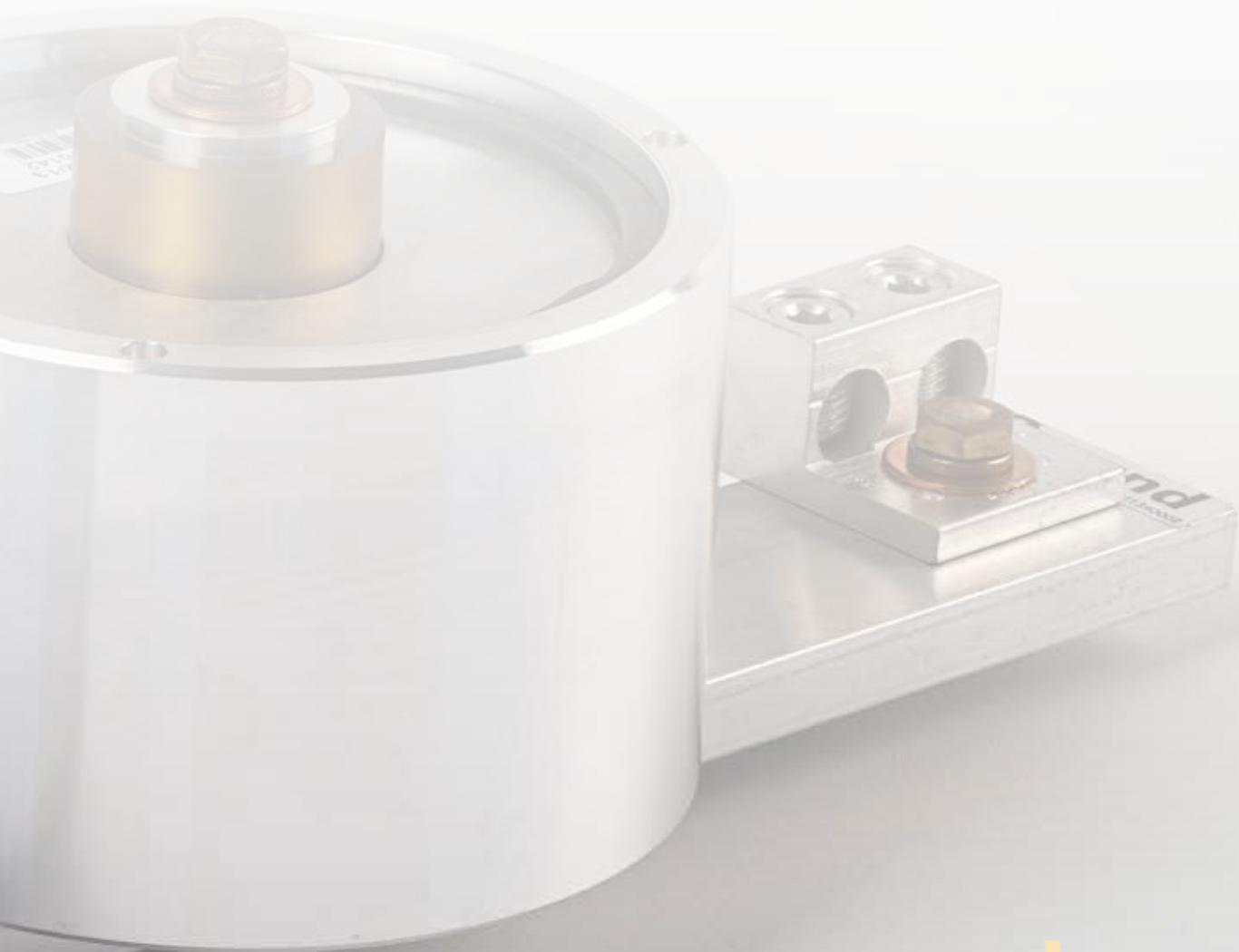

Raycap

Application & Installation Guidelines



Table of Contents

Preface	5
Strikesorb Surge Suppression Modules	6
Introduction	
Strikesorb Options	7
Strikesorb Types Available	
Strikesorb Interconnection Options	8
Modes of Protection	8
Selecting Module Type	8
Mechanical Properties	9
Torque Recommendations	10
Strikesorb Integrated Applications	11
Rayvoss Stand-Alone Surge Protection Devices	12
Introduction	
Rayvoss Options	12
Selecting Module Type	
Rayvoss Product Selection Guide	13
Typical Product Configurations	14
Optional Features	21
Rayvoss Installation Guidelines	22
Direct Connection	22
Key Advantages	22
T-Connection	23
Installation Notes	24
Installation Instructions	25





Raycap



UL US CE

Electrical Ratings		UL 1449 5th ed.		Strikesorb 40-D	
Type	2			IEC 61643-11 (ed. 1.0)	
MCOV	480V			EN 61643-11:2012	
Freq.	50/60Hz			Class I	
In	20kA			Uc	480V AC
VPR	1800V			limp	12.5kA (10/350) ITL
				Up	1800V

Strikesorb 40-D

Raycap



UL US CE

Preface

This document provides technical information on Raycap's Strikesorb Surge Suppression Modules and Rayvoss stand-alone Surge Protective Devices (SPDs). An introduction to the principle of operation of Raycap's Strikesorb technology is briefly presented. The technical characteristics of available types, the interconnection options, and the selection of the appropriate Strikesorb type for many power system configurations, as well as the methodology for integrating Strikesorb modules into the cabinets of large systems, is described in detail.

Strikesorb modules are the basic elements of Rayvoss SPD systems. The internal configuration of a Rayvoss system, which depends on the power system configuration, the required level of protection, and the desired additional features, is different for every Rayvoss type. The unique design of Rayvoss SPDs does not include or require any type of dedicated internal thermal disconnect mechanism (fuses, breakers, etc.), allowing the Rayvoss to be connected directly to a large size breaker or fuse. This provides for two possible installation options for Rayvoss SPD systems:

- **Direct Connection on the power lines**
Rayvoss is the only SPD device that can be safely installed in-line directly on the power lines on the load side of a main breaker or fuse.
- **T-Connection**
This is the conventional method of connecting a SPD in a branch via an appropriate circuit breaker or fuse.

A Product Selection Guide for Rayvoss systems is shown on page 13.

Detailed installation instructions for the Direct or T-Connection of Rayvoss system are also provided.

Updated product information can be found on the Raycap website: raycap.com. The site provides detailed information of the following:

- Rayvoss Brochure, Datasheets, Application Notes, White Papers
- Comprehensive presentation of Strikesorb's principles of operation
- Features and benefits of Strikesorb/ Rayvoss unique technology



Strikesorb® Surge Suppression Modules

Introduction

The Strikesorb surge suppression module is used either as a stand-alone protection element in integrated solutions or within a Rayvoss SPD system. It incorporates a single, heavy duty, distribution grade metal oxide varistor (MOV) disk, assembled under pressure in an environmentally sealed aluminum casing.

Strikesorb's unique design provides very low internal contact resistance and uniform distribution of the surge current over the total area of the protection element resulting in low current density which guarantees the lowest let-through voltages. Furthermore, the excellent thermal management of the MOV due to its aluminum housing provides extremely high energy handling capability. Strikesorb's design minimizes the effects of aging and completely eliminates the risk of catastrophic failure, explosion or fire.

Strikesorb incorporates state of the art developments in metal oxide technology providing superior protection characteristics, which remain unchanged throughout its long service life. The modules have been designed to withstand repeated surges providing cost-effective and maintenance free operation in harsh environments.

Strikesorb is the only UL 1449 5th Edition recognized surge protection module in the industry rated for safe operation without the use of internal fuses or internal thermal disconnects. This unique feature, combined with its capability to be connected directly on the power lines (feed-through connection), makes it the most reliable surge protection device known and ensures that critical electronic equipment will remain protected at all times. Strikesorb 40mm and 80mm modules are certified as Class I surge protection devices per the IEC 61643-11.

Strikesorb Options

Strikesorb (AC) Types Available

- Strikesorb-40**
 This module includes a single MOV disc of 40mm diameter, provides protection from surges up to 140kA (8/20µs), and can be used in all applications.
- Strikesorb-80**
 This module includes a single MOV disc of 80mm diameter and provides protection from surges up to 200kA (8/20µs). It is recommended for use in locations where the risk of direct lightning strikes is high, or at locations with a history of frequent surge-related equipment failures.

Nominal Operating Voltage:
 The normal rms voltage at which the Strikesorb module is designed to operate. This value is determined by the power system voltage.

For example, if the Strikesorb module is to be connected between line to neutral on a single-phase, 120V system, then Strikesorb 40-A or Strikesorb 80-A should be used for this application.

Maximum Continuous Operating Voltage (MCOV):
 The maximum designated rms value of the voltage that may be continuously applied to the Strikesorb module.

Maximum Surge Current Rating (8/20µs):
 The maximum surge current (8/20µs waveform), that the surge suppression module can withstand, as specified in IEEE C62.41-2, without damage or deterioration of its performance.

There are multiple Strikesorb surge protection modules available, some of the more commonly used for Rayvoss are shown in the table below:

Product ID	Nominal Operating Voltage	Maximum Continuous Operating Voltage (MCOV)	Maximum Surge Current Rating (8/20 µs)	SPD Class I per IEC 61643-11
 Strikesorb 40-A	120V	150V	140kA	12.5kA 10/350µs
Strikesorb 40-B	240V	300V	140kA	12.5kA 10/350µs
Strikesorb 40-C	277V	350V	140kA	12.5kA 10/350µs
Strikesorb 40-D	480V**	550V***	140kA	12.5kA 10/350µs
Strikesorb 40-E	480V	600V	140kA	12.5kA 10/350µs
Strikesorb 40-F	600V	750V*	140kA	12.5kA 10/350µs
Strikesorb 40-G	1000V	1200V	140kA	12.5kA 10/350µs
 Strikesorb 80-A	120V	150V	200kA	25kA 10/350µs
Strikesorb 80-B	240V	300V	200kA	25kA 10/350µs
Strikesorb 80-C	277V	350V	200kA	25kA 10/350µs
Strikesorb 80-D	480V**	550V***	200kA	25kA 10/350µs
Strikesorb 80-E	480V	600V	200kA	25kA 10/350µs
Strikesorb 80-F	600V	750V*	200kA	25kA 10/350µs

* 690V per IEC 61643-11
 ** 400V per IEC 61643-11
 *** 480V per IEC 61643-11

Strikesorb Interconnection Options

Modes of Protection

The way that Strikesorb is connected to the power system determines the mode of protection that Strikesorb will provide. There are four possible interconnection options described in the following table:

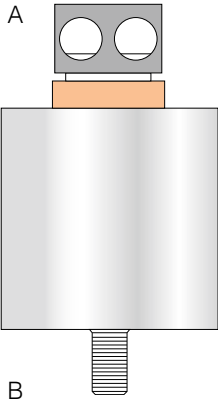
	Connector		Mode of Protection	System
	A	B		
	L	G	Line-to-Ground (L-G)	Single-phase Split-phase Three-phase
	L	N	Line-to-Neutral (L-N)	Single-phase Split-phase Three-phase (with neutral wire)
	N	G	Neutral-to-Ground (N-G)	Single-phase Split-phase Three-phase (with neutral wire)
	L	L	Line-to-Line (L-L)	Single-phase Split-phase Three-phase

Selecting Module Type

The Strikesorb module selection is based on the following two criteria:

- **Nominal Operating Voltage:** This is the rms voltage measured between the two points (A and B) that Strikesorb module will be connected to.
- **Surge Current Withstand Capability:** In critical applications where severe lightning and/or abnormal utility supply is expected, Strikesorb 80 should be considered.

Product Selection Example

Requirements:

- **Power System:** Three-phase with neutral
- **System Voltage:** 480V rms Line-to-Line (L-L)
- **Required Mode of Protection:** Line-to-Ground (L-G)
- **Application:** Protection Variable Frequency Drives (VFD) from lightning and power surges

In this application three Strikesorb modules are required to be installed between each line conductor and the ground. The protection modules should be able to withstand the thermal energy generated by periodic transients produced by the inverter circuit in addition to utility-generated surges, therefore Strikesorb 80-C or 40-C is recommended.

Mechanical Properties

The table below shows the primary mechanical properties of Strikesorb 40 and 80 modules.

Mechanical Properties	Strikesorb 40	Strikesorb 80
Diameter inch [cm]	6.35 - 7.0 cm [2.5" - 2.76"]	10.79 cm [4.25"]
Height inch [cm]	9.46 - 10.78 cm [3.73" - 4.24"]	9.45 cm [3.72"]
Weight lbs [kg]	6.04 - 8.0 kg [1.33 - 1.76 lbs]	1.5 - 1.55 kg [3.31 - 3.41 lbs]

The mechanical drawings of the Strikesorb 40 and Strikesorb 80 modules are shown below.

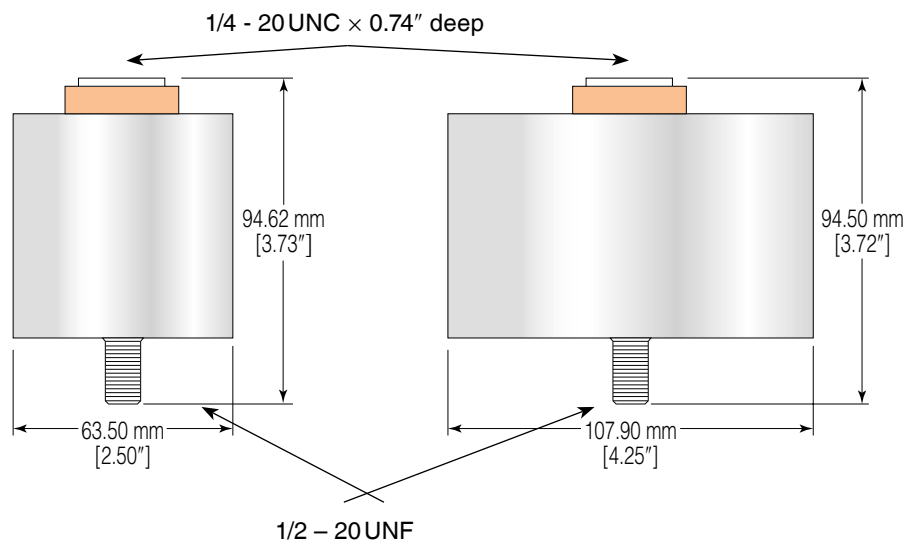

Torque Recommendations

The following illustration provides the recommended torque values for secure mounting of Strikesorb modules on ground bars and busbars. In addition, it provides the recommended torque values for attaching the wires into the mechanical connector, for different wire sizes.

Torque Recommendations for Strikesorb Module Assembly

Example:

$$60 \text{ in-lbs} = 60 \times 0.113 = 6.8 \text{ Newton Meters (Nm)}$$

Connector to Feeder Conductors

- #14 - #10 AWG – 35 in-lbs
- #8 AWG – 40 in-lbs
- #6 - #4 AWG – 45 in-lbs
- #3 - 2/0 AWG – 50 in-lbs

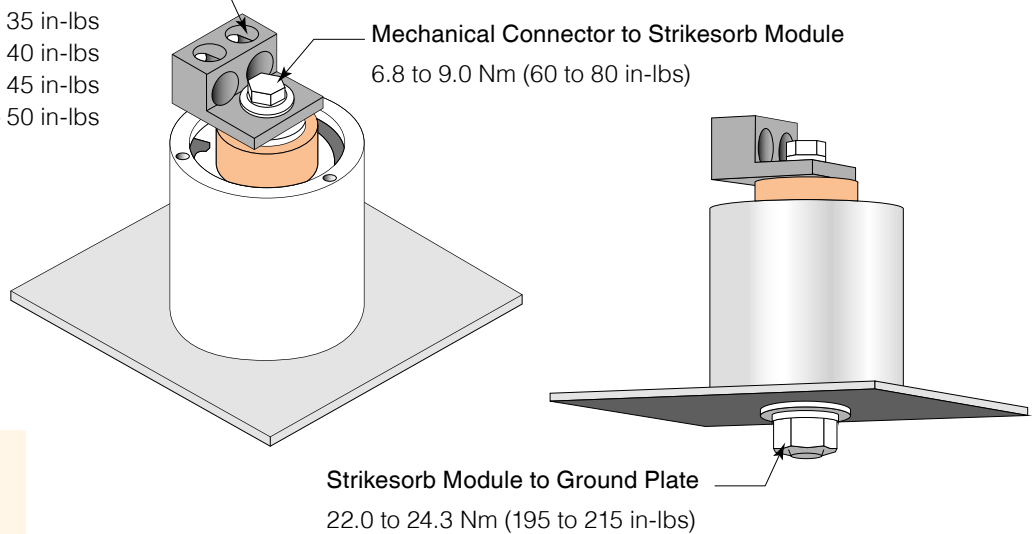

Unit Conversion:

1 in-lb = 0.113 Newton Meter

AWG=American Wire Gauge

Strikesorb Integrated Applications

Strikesorb surge suppression modules are the basic elements of the Rayvoss SPD systems which are described in the following sections. They can also be used as stand-alone SPDs integrated into large systems. Integrating Strikesorb modules into the equipment provides the highest level of protection due to the elimination of the interconnecting cables. Strikesorb modules can be directly connected inside the cabinet after the main circuit breaker. Due to the absence of lead wires and internal disconnect mechanisms, this installation method provides the lowest let-through voltage to the equipment.

Typical applications of the integrated solutions include:

- Variable Frequency Drives (VFDs)
- Telecommunication Equipment: Base Stations, Exchange Nodes, Street Cabinets, Optical Node Units (ONU), etc.
- Uninterruptible Power Supplies (UPS)
- Electrical Submersible Pump (ESP)

Strikesorb modules can be integrated into any cabinet provided there is sufficient space inside the cabinet to install the modules.

A general interconnection diagram showing the direct connection of Strikesorb modules on busbars is illustrated below:

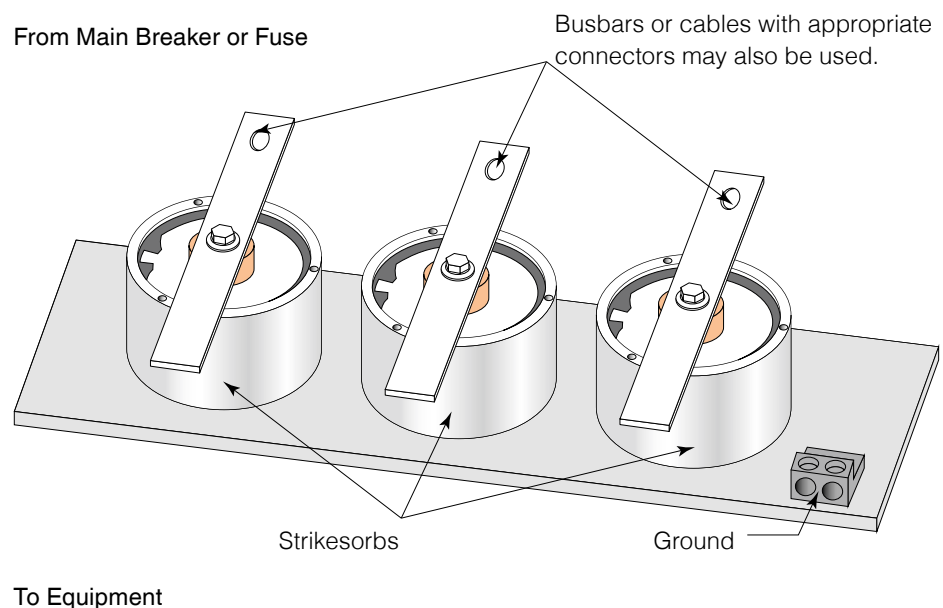

Rayvoss® Stand-Alone Surge Protection Devices

Introduction

General

Rayvoss SPD systems deploy Strikesorb suppression modules in a variety of configurations and operating voltages:

- **Single Phase / Split Phase:** 120V to 240V
- **Three Phase Wye:** 120/208V, 220/380V to 240/415V, 277/480V, 347/600V
- **Three Phase Delta:** 240V, 480V, 600V

Rayvoss SPD products provide continuous protection from lightning, temporary over voltage and other transient voltage activity on a stand-alone basis at the building entrance and distribution panels where critical equipment is connected.

Rayvoss System with Four Strikesorb Modules



Rayvoss A
277-3Y-A1-4-06-C-H

Rayvoss Product Selection Guide

The Rayvoss Product Selection Guide is a helpful tool when determining the right Rayvoss for an application based on operating voltage, distribution type, enclosure size, and other variables.

The information in this guide is intended to aid in the selection of a Rayvoss SPD suitable for your installation.

For further assistance please contact Raycap Sales at info@raycap.com or your area representative.

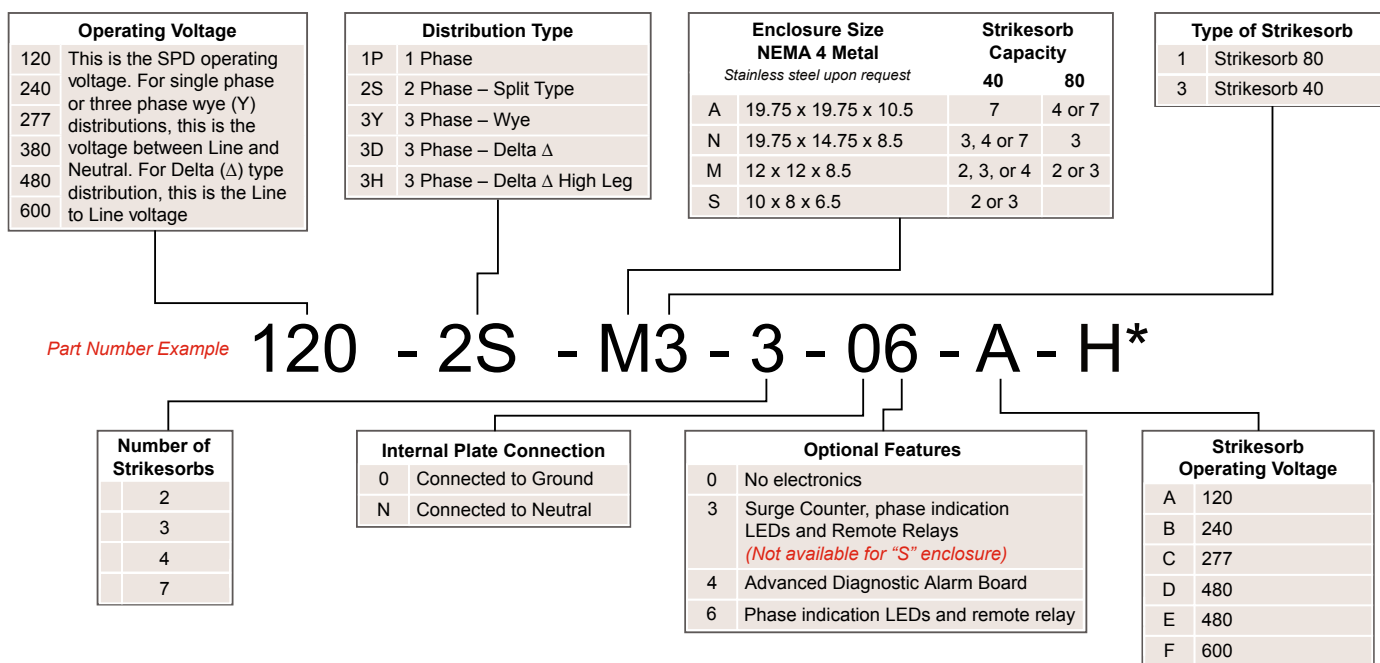

**For a stainless steel enclosure specify "-SS" in place of the "-H" indication which is for the standard painted NEMA 4 enclosure.*

Typical Product Configurations

Rayvoss is available in a variety of configurations to match local electrical system requirements. The following table lists the most common configurations. Rayvoss can also be customized to fit special applications.

Electrical System Configuration	General Interconnection Diagram	
<p>System Voltage: 120V or 220V Single Phase</p> <p>Circuit Type: 2W + G</p> <p>Protection Mode: L-G, N-G</p>		
Rayvoss Configuration	Notes	Rayvoss Models
	<p>2 module system suitable for most applications</p>	<p>120-1P-M1-2-0x-A-H</p> <p>120-1P-S3-2-0x-A-H</p> <p>120-1P-M3-2-0x-A-H</p> <p>240-1P-M1-2-0x-B-H</p> <p>240-1P-S3-2-0x-B-H</p>
Electrical System Configuration	General Interconnection Diagram	
<p>System Voltage: 120V/240V Split Phase</p> <p>Circuit Type: 2ϕ, 3W + G</p> <p>Protection Mode: L-G, N-G</p>		
Rayvoss Configuration	Notes	Rayvoss Models
	<p>3 module system suitable for most applications</p>	<p>120-2S-N1-3-0x-A-H</p> <p>120-2S-M1-3-0x-A-H</p> <p>120-2S-M3-3-0x-A-H</p>

Legend: Load Strikesorb

Electrical System Configuration

System Voltage: 120V/208V
 Three Phase
 Circuit Type: 3 ϕ , Wye, 4W + G
 Protection Mode: L-G, N-G

General Interconnection Diagram

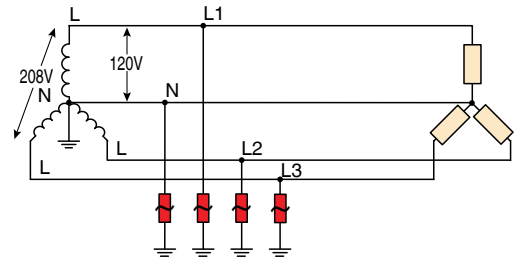

Rayvoss Configuration

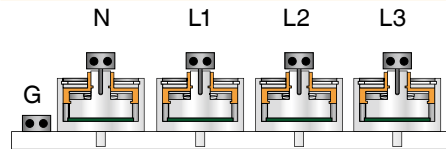

Notes

4 module system
 suitable for most
 applications

Rayvoss Models

120-3Y-A1-4-0x-A-H
 120-3Y-N3-4-0x-A-H
 120-3Y-M3-4-0x-A-H

Electrical System Configuration

System Voltage: 120V/208V
 Three Phase
 Circuit Type: 3 ϕ , Wye, 4W + G
 Protection Mode: L-G, L-N, N-G

General Interconnection Diagram

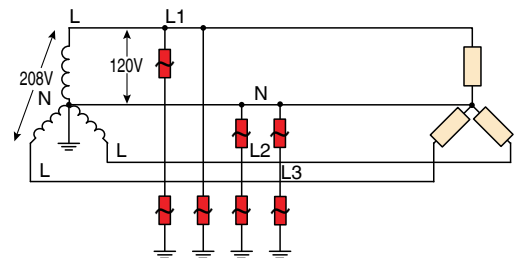

Rayvoss Configuration

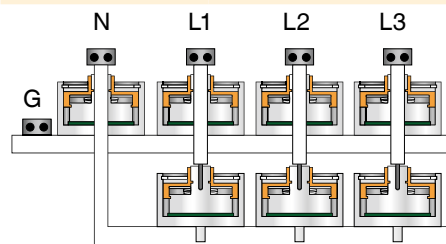

Notes

7 module system
 for applications
 with sensitive
 electronic
 equipment

Rayvoss Models

120-3Y-A1-7-0x-A-H
 120-3Y-N3-7-0x-A-H

Electrical System Configuration

System Voltage: 220V/380V
 Three Phase
 Circuit Type: 3 ϕ , Wye, 4W + G
 Protection Mode: L-G, N-G

General Interconnection Diagram

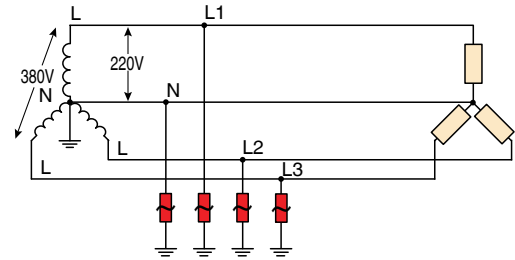

Rayvoss Configuration

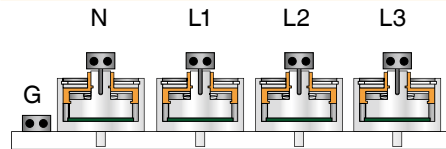

Notes

4 module system
 suitable for most
 applications

Rayvoss Models

240-3Y-A1-4-0x-B-H
 240-3Y-N3-4-0x-B-H
 240-3Y-M3-4-0x-B-H

Electrical System Configuration

System Voltage: 220V/380V
 Three Phase
 Circuit Type: 3 ϕ , Wye, 4W + G
 Protection Mode: L-G, L-N, N-G

General Interconnection Diagram

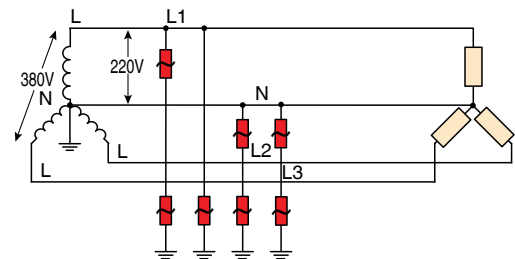

Rayvoss Configuration

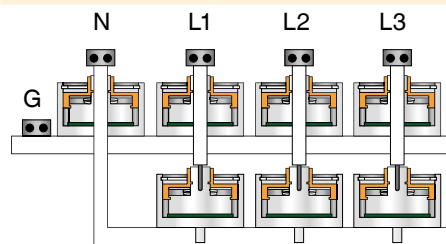



Notes

7 module system
 for applications
 with sensitive
 electronic
 equipment

Rayvoss Models

240-3Y-A1-7-0x-B-H
 240-3Y-N3-7-0x-B-H

Legend:  Load  Strikesorb

Electrical System Configuration

System Voltage: 277V/480V
 Three Phase
 Circuit Type: 3 ϕ , Wye, 4W + G
 Protection Mode: L-G, N-G

General Interconnection Diagram

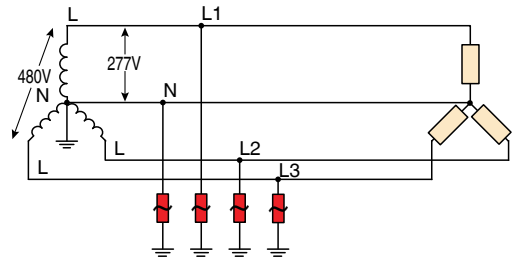

Rayvoss Configuration

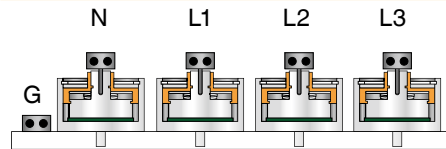

Notes

4 module system
 suitable for most
 applications

Rayvoss Models

277-3Y-A1-4-0x-C-H
 277-3Y-N3-4-0x-C-H
 277-3Y-M3-4-0x-C-H

Electrical System Configuration

System Voltage: 277V/480V
 Three Phase
 Circuit Type: 3 ϕ , Wye, 4W + G
 Protection Mode: L-G, L-N, N-G

General Interconnection Diagram

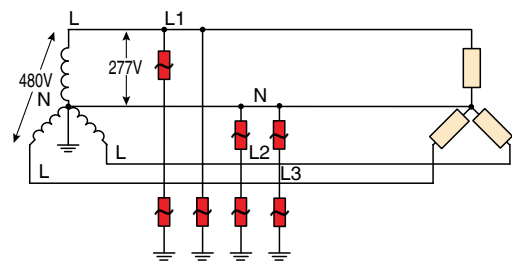

Rayvoss Configuration

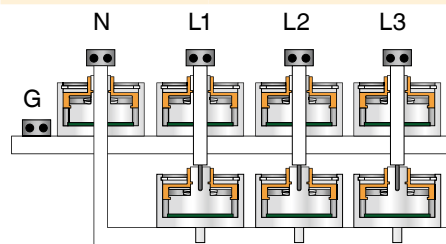

Notes

7 module system
 for applications
 with sensitive
 electronic
 equipment

Rayvoss Models

277-3Y-A1-7-0x-C-H
 277-3Y-N3-7-0x-C-H

Electrical System Configuration

System Voltage: 347V/600V
 Three Phase
 Circuit Type: 3 ϕ , Wye, 4W + G
 Protection Mode: L-G, N-G

General Interconnection Diagram

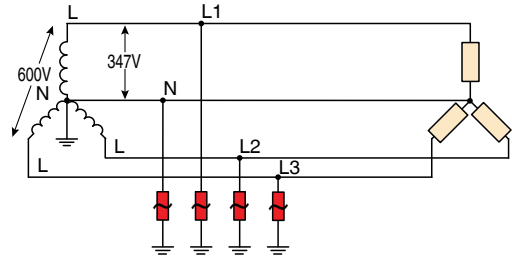

Rayvoss Configuration

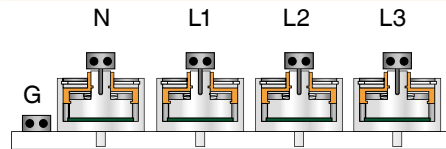

Notes

4 module system
 suitable for most
 applications

Rayvoss Models

347-3Y-A1-4-0x-D-H
 347-3Y-N3-4-0x-D-H
 347-3Y-M3-4-0x-D-H

Electrical System Configuration

System Voltage: 347V/600V
 Three Phase Wye
 Circuit Type: 3 ϕ , Wye, 4W + G
 Protection Mode: L-G, L-N, N-G

General Interconnection Diagram

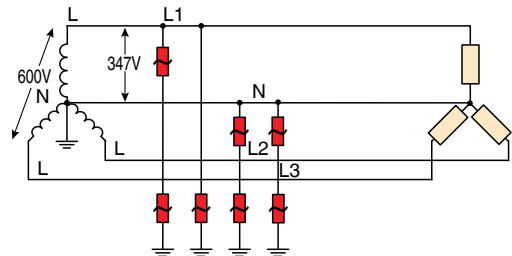

Rayvoss Configuration

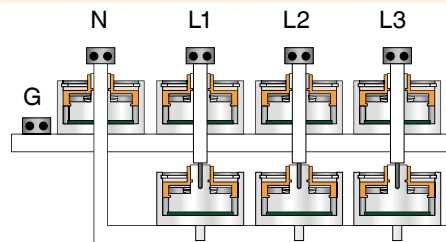

Notes

7 module system
 for applications
 with sensitive
 electronic
 equipment

Rayvoss Models

347-3Y-A1-7-0x-D-H
 347-3Y-N3-7-0x-D-H

Legend: Load Strikesorb

Electrical System Configuration

System Voltage: 240V High-Leg
Delta
Circuit Type: 3 ϕ , Delta, 4W + G
Protection Mode: L-G, CT-G

General Interconnection Diagram

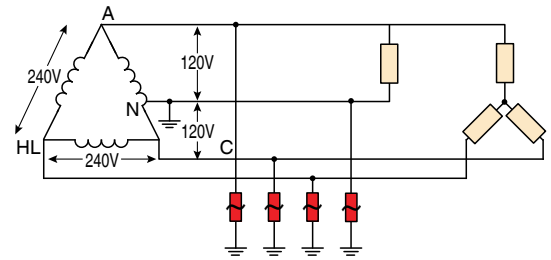

Rayvoss Configuration

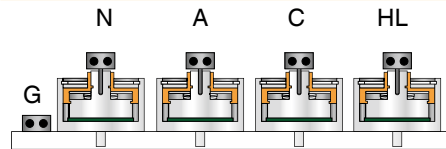

Notes

4 module system
suitable for most
applications

Rayvoss Models

- 240-3H-A1-4-0x-B-H
- 240-3H-N3-4-0x-B-H
- 240-3H-M3-4-0x-B-H

Electrical System Configuration

System Voltage: 240V Three Phase
Delta
Circuit Type: 3 ϕ , Delta, 3W + G
Protection Mode: L-G

General Interconnection Diagram

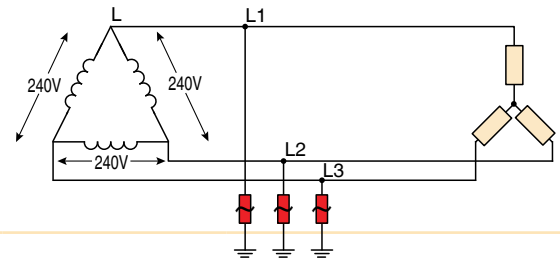

Rayvoss Configuration

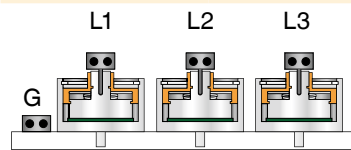

Notes

3 module system
suitable for most
applications

Rayvoss Models

- 240-3D-N1-3-0x-B-H
- 240-3D-N3-3-0x-B-H
- 240-3D-M3-3-0x-B-H

Electrical System Configuration

System Voltage: 480V Three Phase
 Delta
 Circuit Type: 3 ϕ , Delta, 3W+G
 Protection Mode: L-G

General Interconnection Diagram

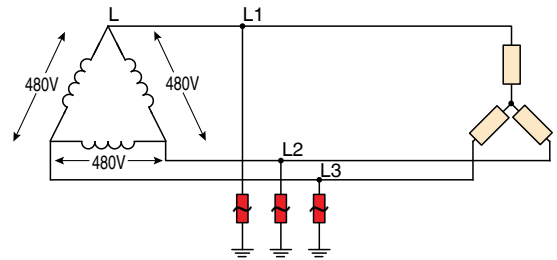

Rayvoss Configuration

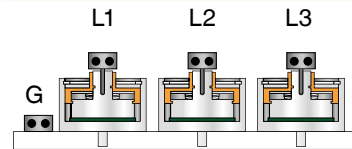



Notes

3 module system
 suitable for most
 applications

Rayvoss Models

- 480-3D-N1-3-0x-D-H
- 480-3D-N3-3-0x-D-H
- 480-3D-M3-3-0x-D-H

Legend:  Load  Strikesorb

Optional Features

OPTION 3: Surge Counter, Phase Indication LEDs and Remote Relays

Normal operation is indicated by the illumination of green LEDs. In the event of a fault or loss of power, the respective LEDs will go OFF. There are also dry contacts available which can be connected to a remote alarm system. Option 3 also includes a surge counter.

OPTION 4: Advanced Diagnostics Alarm Board

Features Diagnostic Monitoring from a full color LCD touch screen display, available on "M" enclosures with any connection configuration. Normal operation is indicated by the illumination of green LEDs. In the event of a fault or loss of power, the respective LEDs will go OFF and an audible alarm will sound.

OPTION 6: Phase Indication LEDs and Remote Relays

Normal operation is indicated by the illumination of green LEDs. In the event of a fault or loss of power, the respective LEDs will go OFF. There are also dry contacts available which can be connected to a remote alarm system.

Optional Enclosure Features

Rayvoss standard metal enclosure is NEMA 4 rated and available in four standard sizes which can be equipped with multiple features and options.

Stainless steel enclosures are also NEMA 4X rated and available with the same standard options and features.*

**For a stainless steel enclosure specify "-SS" in place of the "-H" indication which is for the standard painted NEMA 4 enclosure.*

Rayvoss Installation Guidelines

There are two ways to install Rayvoss systems:

- **Direct Connection** – the ability to provide true continuous protection to downstream equipment. This method provides the lowest possible let-through voltage. In addition, it never leaves the equipment unprotected.
- **T-Connection** – traditional method of connection to the electrical system through a branch fuse or circuit breaker.

Direct Connection

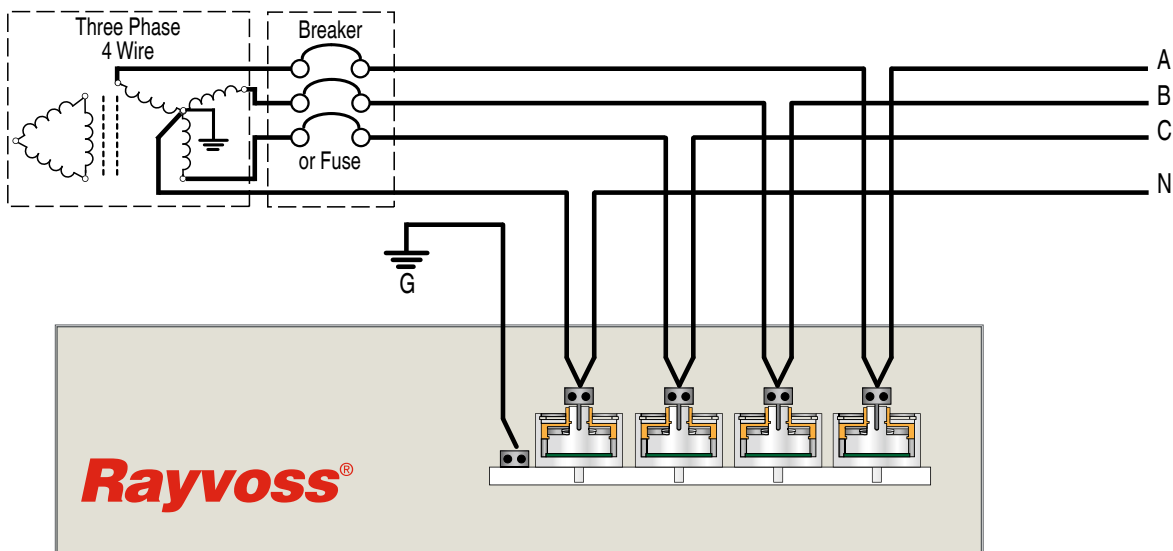

Key Advantages of the Direct Connection

- **Zero Lead Length** – The modules are directly connected to the electrical system offering the lowest possible let-through voltage. The input wires (line and neutral wires) are inserted into the Rayvoss enclosure and are directly connected to one of the two Strikesorb connector ports. The second port of each connector is used to connect the corresponding wire that feeds the equipment, as shown in the diagram on the opposing page. Therefore, no additional lead wires, which can increase the voltage seen by the equipment, are used.
- **Load is Always Protected** – Should a continuous overvoltage event exceed the energy handling capability of Rayvoss, the Strikesorb module goes short and the upstream overcurrent protection device operates. In this way the equipment is taken off-line, protecting it from subsequent exposure to damaging conditions.

T-Connection

T-Connection is used in the following situations where direct connection is not possible:

- Line wire size is greater than 95mm² (#4/0 AWG)

Because Rayvoss systems can use larger size lead wires, they can be connected using bigger fuses compared to those used in conventional SPD systems even when connected in T-configurations. This allows for continuous protection at higher surge currents, and maximum use of Strikesorb's superior capabilities. Wire should be kept as short and straight as possible to avoid increasing the clamping voltage due to the added impedance on the line.

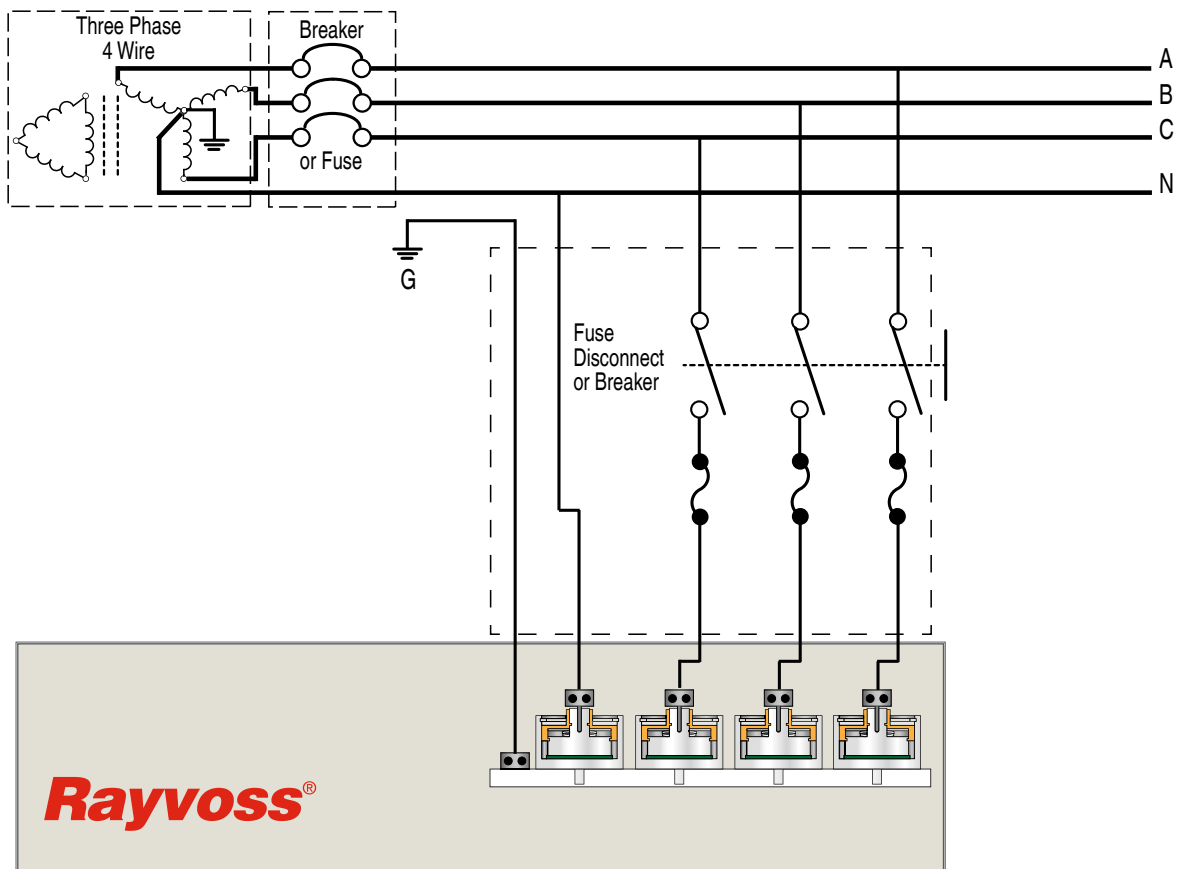

Installation Notes

Rayvoss installations are driven by the size of the enclosure, as indicated in the table below for direct connections and must comply with the national electrical codes:

Enclosure Type	Enclosure Size	Upstream Protection (Fuse or Circuit Breaker Up To)	Maximum Conductor Size
S	254.0 × 203.2 × 165.1 mm [10" × 8" × 6.5"]	50 A	10 mm ² [#6 AWG]
M	304.8 × 304.8 × 215.9 mm [12" × 12" × 8.5"]	100 A	35 mm ² [#2 AWG]
N	501.65 × 355.6 × 215.9 mm [19.75" × 14.75" × 8.5"]	225 A	95 mm ² [#4/0 AWG]
A	501.65 × 501.65 × 266.7 mm [19.75" × 19.75" × 10.5"]	225 A	95 mm ² [#4/0 AWG]

AWG=American Wire Gauge

Before installing, make certain the system voltage and configuration on the nameplate is appropriate for your electrical service.

Installation Instructions

Cautions & Warnings

1. Always select the appropriate Rayvoss type for your electrical system.
2. Rayvoss systems should be installed by qualified electricians.
3. Installation and wiring should conform to the National Electrical Code and applicable local codes.
4. The environmental rating and type of this product will be adversely affected if the incorrect type and rating of conduit fitting or cable gland is installed.
5. Disconnect from energized circuits before installing or servicing.

Mounting

The Rayvoss system needs to be mounted to a solid, flat surface capable of supporting appropriate weight as determined by the size of the enclosure per the table below. It is convenient to install the lower mounting studs/bolts first as the Rayvoss has slotted lower mounting lugs. Once the lower studs/bolts are installed, the Rayvoss may be lowered onto them and the correct location for the upper mounting stud bolts can be marked through the holes in the upper mounting lugs.

Enclosure Type	Enclosure Size	Approximate Support Weight
North American Specifications		
S	254.0 × 203.2 × 165.1 mm [10" × 8" × 6.5"]	4.99kg [11 lbs]
M	304.8 × 304.8 × 215.9 mm [12" × 12" × 8.5"]	9.98kg [22 lbs]
N	501.65 × 355.6 × 215.9 mm [19.75" × 14.75" × 8.5"]	21.32kg [47 lbs]
A	501.65 × 501.65 × 266.7 mm [19.75" × 19.75" × 10.5"]	28.12kg [62 lbs]
European Specifications		
S	199.90 × 334.01 × 163.58 mm [7.87" × 13.15" × 6.44"]	4.99kg [11 lbs]
M	299.97 × 384.05 × 213.61 mm [11.81" × 15.12" × 8.41"]	9.98kg [22 lbs]
N	400.05 × 551.94 × 213.61 mm [15.75" × 21.73" × 8.41"]	21.32kg [47 lbs]
A	500.13 × 583.95 × 263.40 mm [19.69" × 22.99" × 10.37"]	28.12kg [62 lbs]

Grounding

Ground connection is made to the ground terminal mounted on the inside of the Rayvoss enclosure. A short and straight cable should make the connection to the power ground or to the main ground bar at the installation location.

Do not use the mounting lugs for the safety and protection ground.

*Information provided in this document
is subject to change without notice.*

Raycap Worldwide Locations

Raycap Inc.

806 South Clearwater Loop
Post Falls, ID 83854
United States of America

7555-A Palmetto Commerce Pkwy
North Charleston, SC 29420
United States of America

46 Sellers Street
Kearny, NJ 07032
United States of America

Raycap GmbH

Parking 11
85748 Garching Munich
Germany

Raycap S.A.

Telou & Petroussou 14
15124 Maroussi Athens
Greece

Raycap S.A. Manufacturing

Industrial Area of Drama
66100 Drama
Greece

Raycap d.o.o.

Pod hrasti 7
Poslovna cona Žeje pri Komendi
1218 Komenda
Slovenia

Raycap Cyprus Ltd.

46 Lefkosias Street
Industrial Area of Dali
2540 Nicosia
Cyprus

Raycap SAS

84 rue Charles Michels
Building. B
93200 Saint-Denis
France

Raycap Corporation SRL

102, Barbu Vacarescu
entrance D, 4th floor, D22
020283 Bucharest
Romania

Raycap (Suzhou) Co. Ltd.

Block B, Phase II
of New Sea Union
No. 58 Heshun Road
SIP, Suzhou 215122
Jiangsu Province
China



Raycap

raycap.com • info@raycap.com

Raycap, Rayvoss and Strikesorb are registered trademarks.
© 2024 Raycap All rights reserved.
G09-00-116 240404