

Raycap

SMALL CELL CONCEALMENT

PRODUCT GUIDE



TABLE OF CONTENTS



Company	4 - 9
About Raycap	6
North American Facilities & Capabilities	7
Small Cell Products and Services	8 - 9
Small Cell Poles	10 - 27
Small Cell Pole Overview	12
Small Cell Pole Shapes	14 - 15
RaycapSTAX™ Modular Pole Solutions	16 - 17
Pre-Fab Foundations	20
Structural Bases	21
Decorative Bases	22
Luminaires	23 - 25
Light Arms	26 - 27
Shroud Solutions	28 - 49
Pole Top Shrouds	29
Cable Shrouds/Radio Masks	30
Mid-Pole Shrouds	31 - 35
4G+5G Wood Pole Top Mounts	38
4G+5G Wood Pole Side Mounts	39
4G+5G Wood Pole Modular Components	40 - 43
4G+5G Wood Pole Extension Mounts	44
Complete Side-Mounted Solutions	44
Galvanizing, Powder Coating & Painting	45
Artist Painting	45
Laser, Plasma Cutting, Forming & Rolling	46
Welding & Assembly	47
Small Cell Pole Photo Gallery	48
Pole Top Shrouds Photo Gallery	49
Power Management Solutions	52 - 61
Strikesorb Surge Protection	52
Meterbase	54
AC Disconnects	55 - 59
Mounting Pedestals & Meter Socket	60
AC/DC Combo Power Management	61
Fiber Management Solutions	62 - 65
Fiber Enclosures	64
Fiber Cabinets	65
Specialized Concealment & Indoor DAS Systems ..	66 - 71
Rooftop Solutions	68 - 69
Wall Mounted Solutions	70
Wall & Rooftop Solutions Gallery	71
Research & Development	74 - 85
Standards & Certifications	74
Testing & Measurement	75 - 83
InvisiWave® Solutions	84
Panel & Rooftop Products	85
Services	88 - 91
Product Design & Integration	88
Photo Simulations	89
Thermal Analysis & Active Cooling	90
Site Visits, Survey & Structural Analysis	91
Appendix	92



COMPANY

ABOUT RAYCAP

Raycap is a global solutions provider with a clear vision of the future network, a result of many years of research and development in the telecommunications field and our continuous engagement with the leading companies in our industry, including partners, customers, suppliers, current and future stakeholders of the network. We have proven to be a thought-leader in our space, and our edge is in the design of high throughput, high-density, and multi-technology passive solutions. We possess a unique capability to quickly turn concepts and innovative ideas into industrialized, cost-efficient products, providing realistic solutions and support in any network infrastructure.

Twenty-five years ago, the telecommunications landscape was much different than today – cell phones were larger, smart phones were nonexistent, and society was not connected by technology 24 hours a day, seven days a week. Since then, the industry has grown immensely with new equipment and increased demand from mobile operators for more expanded and hardened networks. The latter necessitates the installation of numerous apparatus such as remote radio heads, small cells, antennas, and microwave links located on tower tops, rooftops, and even at street level, which must be concealed.

Raycap has one goal in mind: to provide our customers the best design, R&D, engineering, manufacturing, and sales support to be a one-stop-shop for customers looking to build out their next-generation networks.



NORTH AMERICAN FACILITIES & CAPABILITIES

Post Falls IDAHO

95,000 square foot plant with engineering, product development, manufacturing, assembly and testing facilities.

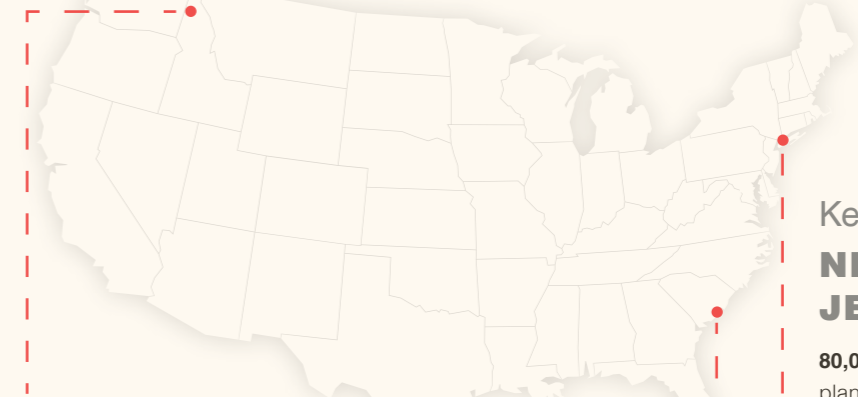

Kearny NEW JERSEY

80,000 square foot plant with engineering, product development, manufacturing, assembly of radio shrouds, antenna mounts, radio concealment light poles, ground furniture and strand mounts.

International Reach With Locations Near You

Raycap acquired STEALTH Concealment in June 2018 and APELIO Innovative Industries in January 2020. Together, these acquisitions form cornerstones of Raycap's wireless infrastructure concealment experience in North America, working with customers to create aesthetically pleasing and RF-friendly solutions. STEALTH Concealment was the wireless concealment industry pioneer, while APELIO Innovative Industries had expertise in designing and manufacturing infrastructure hardware and electrical switchgear.

Today, the Raycap Group designs and manufactures concealment solutions consisting of small cell light poles, toppers, shrouds, mounts and brackets, rooftop screen walls, cupolas, towers, silos, DAS concealments, and many other custom structures for North American small cell and macro cell sites from its US factories on the East Coast in South Carolina and New Jersey, and on the West Coast in Idaho.

North Charleston SOUTH CAROLINA

200,000 total square foot fabrication and integration facilities with full steel and composite fabrication capabilities plus in-house wet paint and powder coat lines.

SMALL CELL PRODUCTS AND SERVICES



POLE PRODUCTS

- Poles
- Radomes
- Galvanizing, Powder Coating & Painting
- Pre-fab Foundations
- Bases
- Cable Shrouds
- Pole Top Shrouds
- Luminaires & Light Arms
- Mid-Pole Shrouds
- Mounts & Brackets

SERVICES

- Site Visits & Surveys
- Structural Analysis
- Product Design
- Integration
- Thermal Analysis
- Smart Active Cooling
- Photo Simulations

RESEARCH & DEVELOPMENT

- Testing & Measurement
- Standards & Certifications
- Electrical Safety
- InvisiWave® Solutions

POWER MANAGEMENT

- Strikesorb® Surge Protection
- AC Disconnect Solutions
- AC/DC Combo Power Management
- Meter bases
- Mounting Pedestals

FIBER MANAGEMENT

- Fiber Enclosures
- Fiber Cross-connect Cabinets

SPECIALIZED CONCEALMENT SOLUTIONS

- Rooftop Solutions
- Wall Mounted Solutions
- Indoor DAS Solutions



SMALL CELL POLE OVERVIEW

Raycap's concealed and non-concealed small cell poles, including pole toppers and mid-pole shrouds, are built to meet exact specifications and maintain maximum RF performance. Designed for flexibility, performance, and aesthetics, the company offers many pole options, including poles with fluting, various bases, pole top or mid-pole equipment shrouds, light arms and luminaires, mounts, and other hardware. In addition, power and fiber connectivity and power management solutions can be included to enable easy integration and provide protection from electrical overvoltages. No matter your rollout needs, Raycap has the right solution for you.

Hand-holes, doors, internal and external base plates shown for reference and can be engineered per customer custom order. Final configurations to be determined by pole loading and equipment layout.

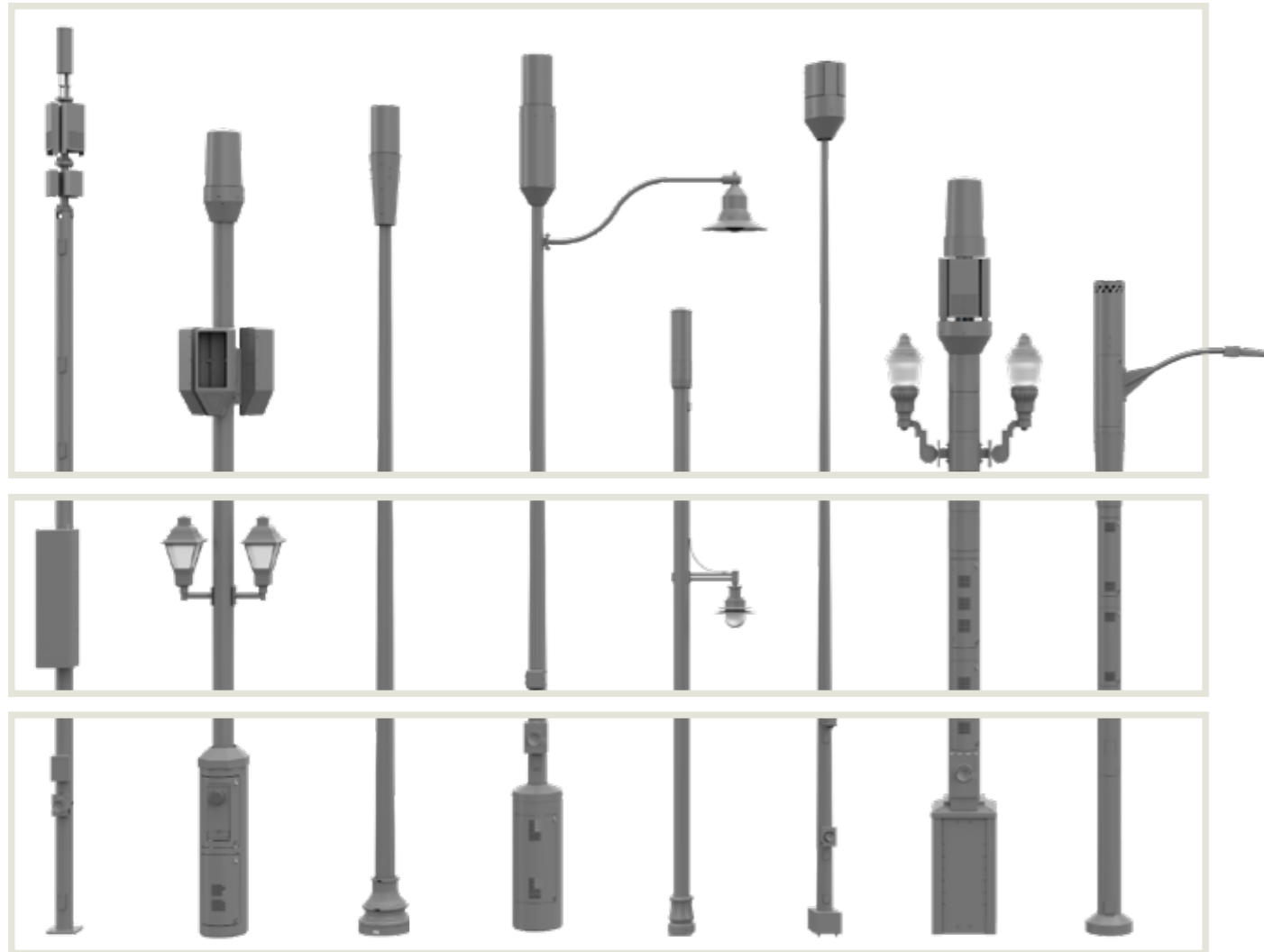

Radio Technology

Small cell poles are designed to customer specifications and delivered fully integrated and concealed, or in any format upon request. Raycap designs can accommodate all radio technologies with many available toppers and shrouds.

Light Arms & Shrouds

Customers can order pole solutions with optional lighting arms, mid-pole shrouds, or attachments to match surrounding light poles. Poles can be designed and engineered to re-use existing luminaires, reducing site costs and lead time.

Bases

Raycap provides decorative bases to be installed around existing poles to hold and conceal power, fiber distribution, and radio equipment. Structural bases are also available and can support an existing or new light pole installed on top.



Seattle Waterfront - bump formed 22"

SMALL CELL POLE SHAPES



15" OD Multi-Sided 8" Fluted Wrap 12" Fluted Wrap 10" Base Diameter 8-Sharp Tapered Flute 10" Base Diameter 12-Tapered "OctoFlute" Round Smooth Tapered Hexagonal Tapered Octagonal-Tapered 10" Base Square Tapered 10" Square Straight 8" Square Straight 8" Round Straight 10" Round Straight 12" Round Straight 12" Round Straight w/ Doors (Integrated) 14" Round Straight w/ Doors 18" Round Straight w/ Doors 20" Round Straight w/ Doors 24" Round Straight w/ Doors 30" Round Straight w/ Doors

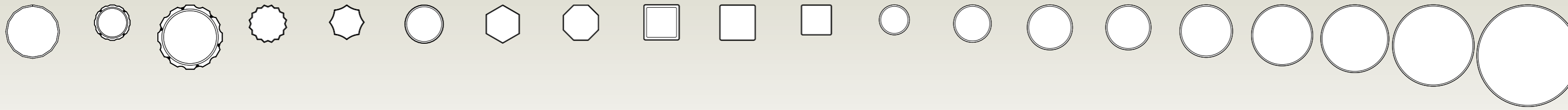

RaycapSTAX™ MODULAR POLE TOPPER

Raycap's new 16", 18", and 22" diameter modular and stackable pole toppers are available in partially and fully concealed designs.

The unique stackable toppers are constructed from structural steel and aluminum following the American Institute of Steel Construction (AISC), and accommodate multiple radio types and antennae housed on top of Raycap steel poles or wooden poles in a 4G/5G cellular network.

The 16" and 18" partially concealed variants have steel structures and aluminum cutouts to accommodate the placement of radios. The fully-concealed 22" version has a steel structure with leaves made of InvisiWave®, Raycap's technology specifically engineered to be minimally invasive to 5G mmWave signals.

Note: Additional pole top mount hardware is required for use on wood poles.



Stacks of up to three modules per pole are possible. The new designs accommodate site flexibility and facilitate the growing 5G and next generation network infrastructure buildout.

RaycapSTAX™ Color Options			
X:	Color	Color #	Color Name
1		6012	Black Green
2		7022	Umbr Grey
3		7013	Brown Grey
4		7040	Window Grey
5		7047	Telegrey 4
6		9011	Graphite Black
7		9005	Jet Black
8		7035	Light Grey
9		9010	Pure White
A		8028	Terra Brown
B		8019	Grey Brown
C		8011	Nut Brown
D		7006	Beige Grey
E		8014	Sepia Brown
F		1019	Grey Beige
G		9017	Traffic Black
H		7001	Silver Grey
J		7037	Dusty Grey
K		9002	Grey White
L		8017	Chocolate Brown
M		7045	Telegrey 1
N		7004	Signal Grey
P		xxxx	Transit Blue
O		6009	Fir Green
R		7038	Agate Grey
S		1001	Beige
T		6028	Pine Green

Color list subject to change. Other colors may be available.



Find the complete RaycapSTAX™ Modular Stackable Toppers catalog under "Resources" at www.raycap.com

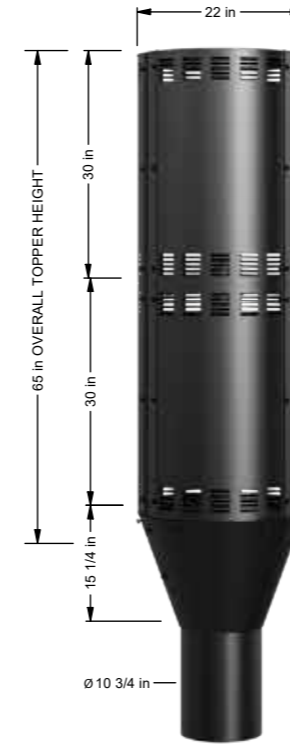

RaycapSTAX™ Modular Topper (Configuration Example A)

Parts List			
Item #	Part #	QTY	Description
1	MTT-2210S1-002-X	1	TAPERED TRANSITION & POLE ADAPTOR
2	MTB-2230S-001-X	2	EQUIPMENT BAY WELDMENT
3	MTR-2230F-002-X	6	VENTED INVISI WAVE RADOME LEAF
4	MTC-22VC-001-X	1	PERFORATED VENTING CAP
5	1423-210	2	TRI RADIO CLAMPING MOUNT (NO TILT)

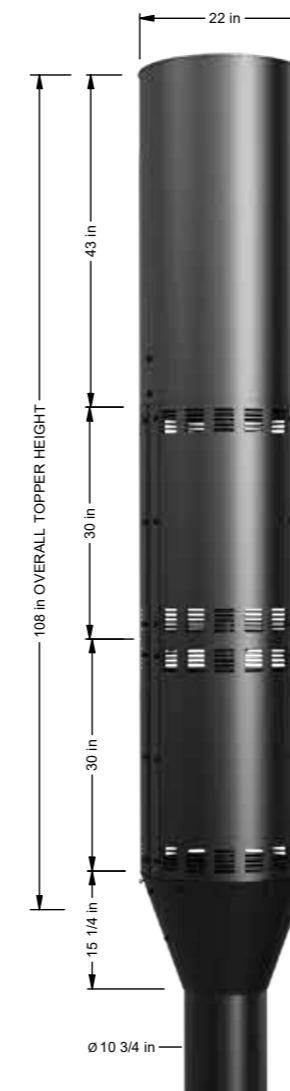
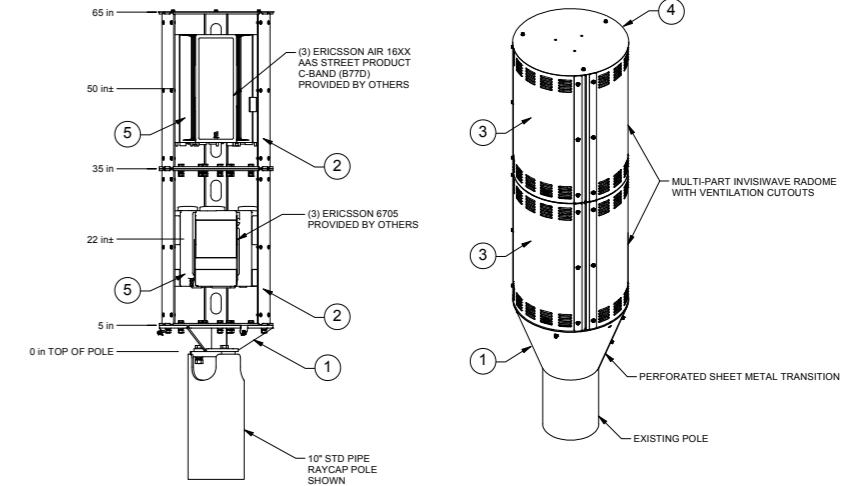

RaycapSTAX™ Modular Topper (Configuration Example B)

Parts List			
Item #	Part #	QTY	Description
1	MTT-2210S1-002-X	1	TAPERED TRANSITION & POLE ADAPTOR
2	MTB-2230S-001-X	2	EQUIPMENT BAY WELDMENT
3	MTR-2230F-002-X	6	VENTED INVISI WAVE RADOME LEAF
4	MTC-2243F-001-X	1	OMNI MOUNT & RADOME KIT
5	1423-210	1	TRI RADIO CLAMPING MOUNT (NO TILT)
6	1423-200	1	DUAL RADIO CLAMPING MOUNT (NO TILT)

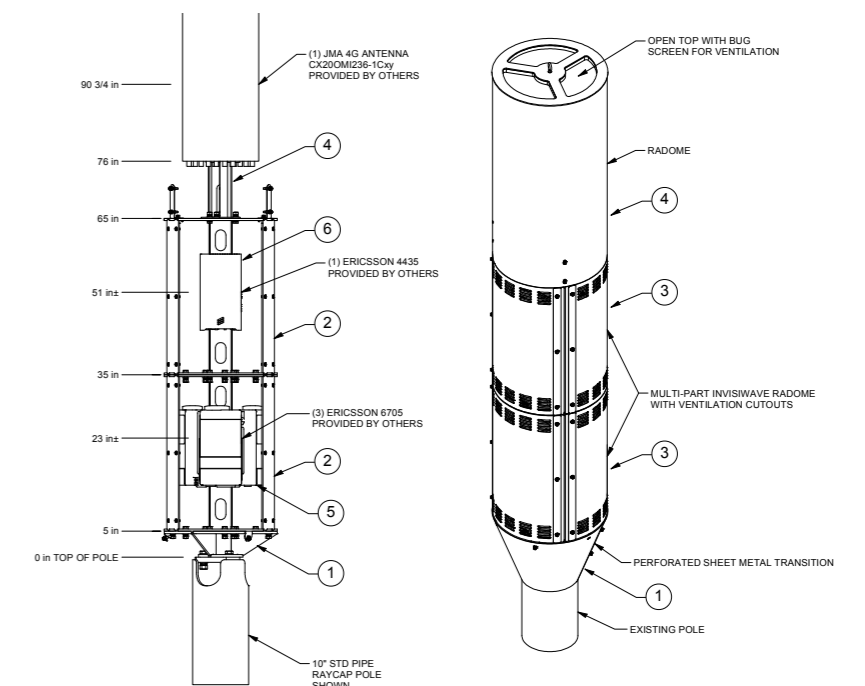

SMALL CELL POLES

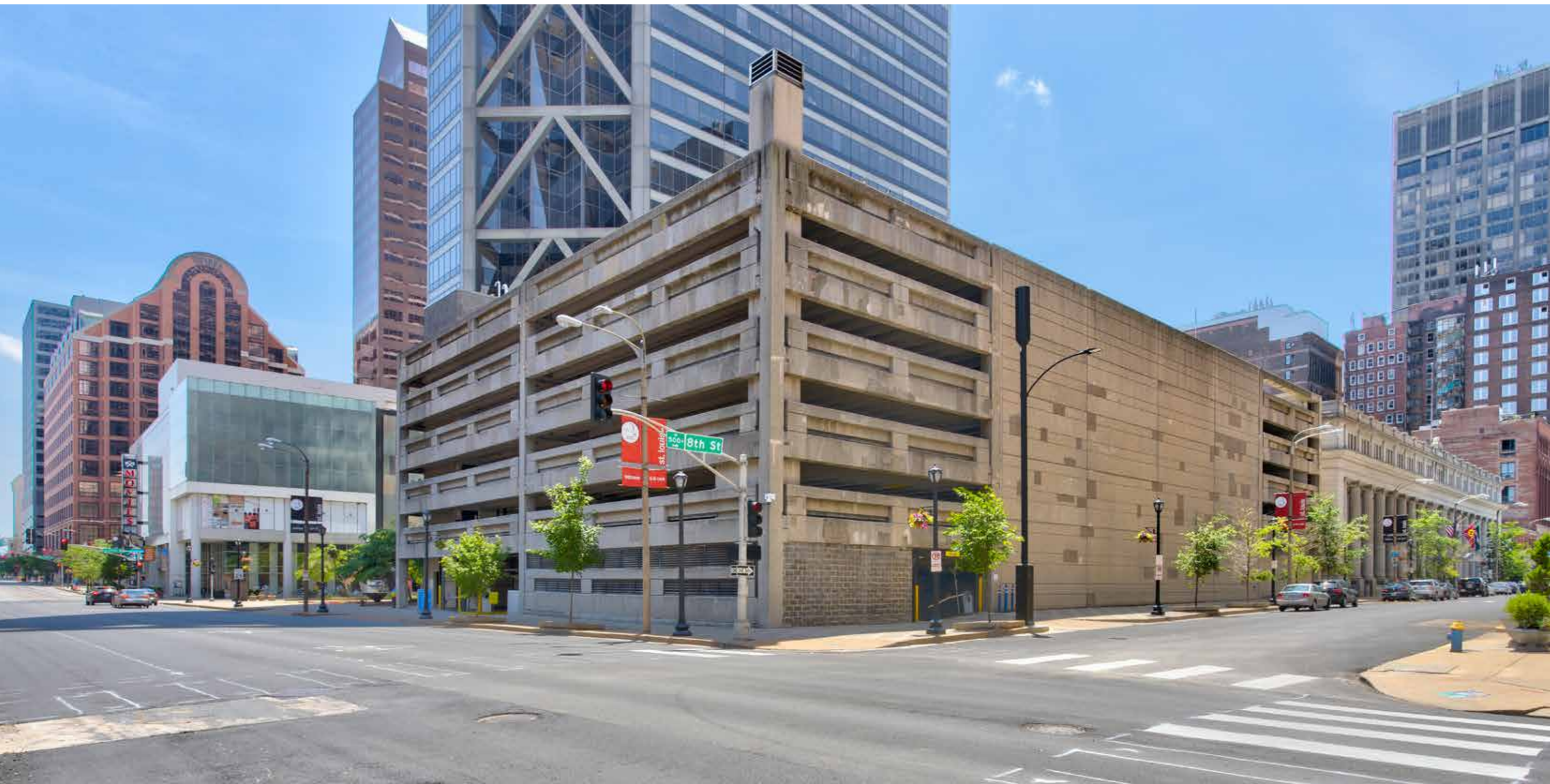

PRE-FAB FOUNDATIONS

Raycap can provide customers with traditional poured-in-place foundation designs, and alternative pre-fabricated foundation options to help expedite deployment.

Pre-fabricated options include:

- Breakaway Pole with Direct Embed
- Breakaway Pole with Helical
- Additional options will require soil backfill, stone backfill and/or concrete backfill
- Note that custom depths and diameters are available to suit any size pole and/or soil conditions

Direct Embed



Helical



STRUCTURAL BASES

Slim Cylindrical

- 18" round pipe x 4' tall
- Structural base, pole bolts on top
- Fans and meter viewing window integrated into door



Cylindrical

- 20" round pipe x 4' tall (pending specific equipment required)
- Structural base, pole bolts on top
- Available in larger pipe diameters and one or two doors
- Pictured with Nola clamshell base (20" pipe only)



Rectangular

- 25" x 25" square x 4' tall
- Structural base, pole bolts on top
- Side panels removable for equipment access



Note: custom sizes available upon request

XL Cylindrical

- 20" round pipe x 8' tall
- Structural base, pole bolts on top
- Robust ventilation system for large quantity of equipment
- Pictured with Nola clamshell base (20" pipe only)



Octagonal

- 36" octagon x 4' tall
- Clamshell base, wraps around wood or steel poles
- Meter viewing window on hinged door



DECORATIVE BASES

Argenta

- 4'4" tall decorative clamshell base cover
- Accepts poles and round structural bases within 8" - 20"



Nola

- 12" tall decorative clamshell base cover
- Designed for 18" or 20" round structural bases



Dallas

- 3'2" tall decorative clamshell base cover
- Accepts poles and round structural bases within 12" - 18"



Sarasota

- 20" tall decorative clamshell base cover
- 16" base outside diameter (OD) for 8" and 10" poles
- Slim design for tight locations in the public ROW or sidewalks



LUMINAIRES

AEL: LED Series 247L

- American Revolution LED, black
- P303 80, 8,400 nominal lumens
- 40K 4000K CCT



Duralight: DURA-STR Cobra Head

- Cobra head housing, grey
- Type II application
- 40K 4000K CCT



AEL: Hartsfield Acorn LED Series HTFL

- Acorn style
- Type III application
- 40K 4000K CCT



AEL: Autobahn Series ATBM Roadway

- Autobahn Roadway LED, black
- Roadway Type IV
- P20 12,800 lumens



Holophane: MPL3 Memphis Pendant

- Memphis style housing, black
- Bowl glass & door, Type III application
- 40K 4000K CCT



AEL: Twist-Lock Photocontrol

- Sensor-based lighting control
- Dimming photocell receptacle - suitable for NEMA 3, 5 or 7-pin receptacle
- Up to 750 watts.



Holophane: ESL3 Esplanade Pendant

- Esplanade style housing, black
- Teardrop glass & door, Type III application
- 40K 4000 CCT



LUMINAIRES

Holophane: LEDGEND2 Roadway Lighting

- Roadway lighting, horizontal mast arm mount
- 27K 2700K CCT
- 34,000 Lumens



Holophane: WAE3 Washington Postlite

- Modern style, hinged door
- 40K 4000K CCT
- 11,200 nominal lumens
- GL3 Glass, Type III



Holophane: AWDE3 Washington Postlite

- Luminaire acrylic
- 30K 3000K CCT
- 3,700 nominal lumens



Spring City: Columbia LED

- LE185, 185 Watts
- CR3 Type III
- Vertical or horizontal alignment



Spring City: Exton LED

- LE 200, 200 Watts
- CRR3 Type III
- Vertical or horizontal alignment



Spring City: Harrisburg Baltimore

- LE040, 40 Watts
- CR3, Type III
- 45K 4500K CCT



KIM Lighting: RA17A2

- Area/Site
- 5K7 CCT, 5000K, 70 CRI



Lumark: NFFLD-S Night Falcon Small

- Floodlight
- C70 2700 nominal lumens
- Slipfitter mounting fits 2 3/8" OD



Lumark: Prevail Discrete LED-XL

- Area/Site
- 70CRI, 4000K
- Type IV Wide Distribution
- 4000K/5000K Lumens



Streetworks: Verd-M Verdeon

- Roadway luminaire
- 210 Watts
- 70 CRI, 400K
- CR3, Type III



Streetworks: Archeon Large

- Roadway luminaire
- 280 Watts
- 80 CRI, 2700K
- 5WQ, Type V Square Wide



Sternberg Lighting GL1970 Large

- Base fixture stepped
- 40L: 40 LEDs
- 40K 4,000K CCT
- T3, Type III



LURA LINE: Helos HL302XL UWM

- Tapered U-arm
- Clear prismatic glass
- Light source max 200W A



Spring City: LE100

- Globe: Clear stippled acrylic
- 100 Watt LED system
- CR Type III



Spring City: Washington-X Simple

- Globe: Clear stippled polycarbonate
- 100 Watt LED system
- CR Type III



LIGHT ARMS

Teardrop

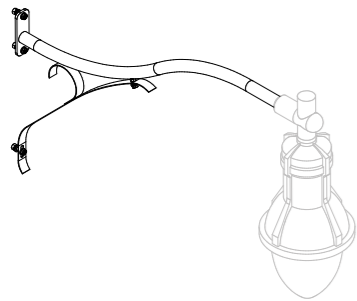

Pendant

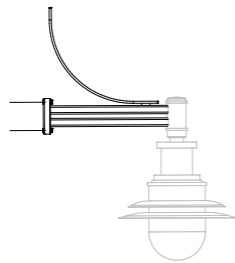

French Quarter

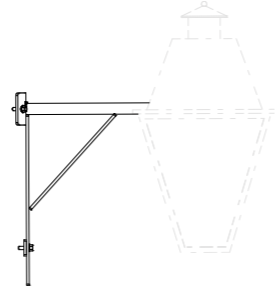

HADCO Penant Adapter with Photocell TFHAM3

- Pendant adapter with photocell receptacle
- 2 3/8" O.D. horizontal arm mounting adapter

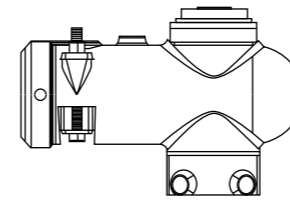

HADCO - PTW2580 Mount & Arm Bracket

- Urban wall mount, black
- Height 16 3/4"
- Length 17 3/4" from wall to end of luminaire



Holophane: Philadelphia Crossarm PCP

- Crossarm, single arm
- Nominal 18" length per arm
- Wall bracket mount 16" actual length
- Super durable corrosion resistant, black

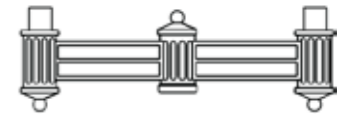

Granville

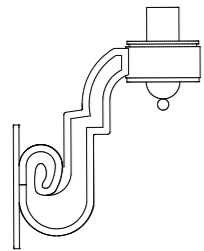

Acorn

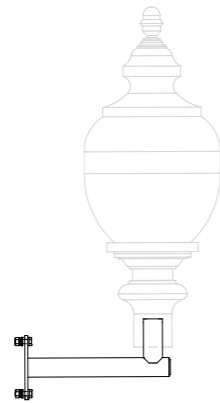

BSL 4

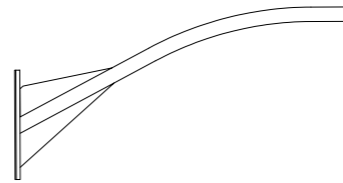

KIM Lighting: Side Pole Sweep Cast Arm 2SBHA11S

- Side arm, cast Aluminum Alloy
- Arm open for access to wiring connections
- Available in large and small version

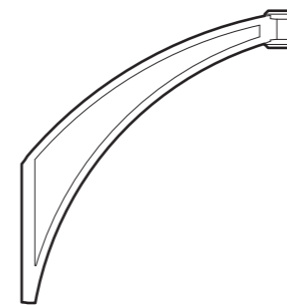

KIM Lighting: Side Pole Sweep HA11 Arm

- Side arm, cast Aluminum Alloy
- Arm open for access to wiring connections
- Available in large and small version

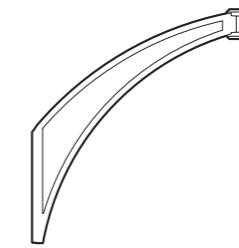

Spring City: Washington Simple Wall Bracket

- Wall bracket, cast Aluminum Alloy
- Height 10"
- Length 21" from wall to end of luminaire

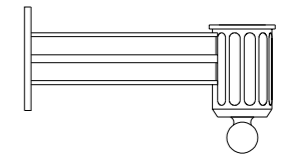

Cobra

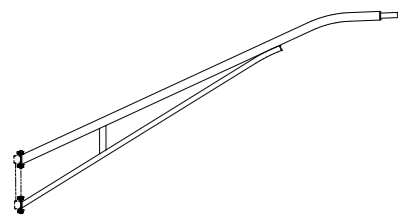

Decorative Pendant

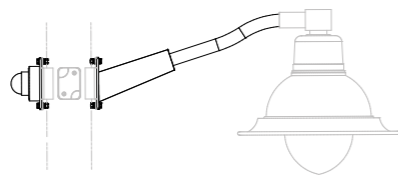

Mongoose

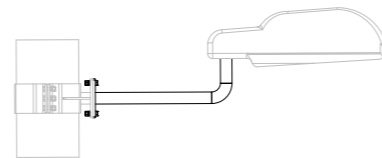

Spring City: Brooklyn Borough

- Wall bracket
- Cast Aluminum Alloy, smooth gloss powder coat, black
- Height: 8 5/8"
- Length: 27 1/8" from wall to end of luminaire

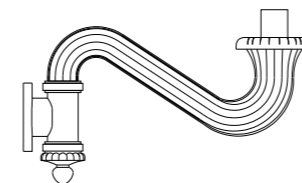

Holophane: Liberty

- Decorative arm fitter
- Quick stem mount
- Super durable corrosion resistant finish, black

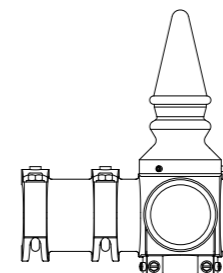

Holophane: Boston

- Decorative arm fitter
- Quick stem mount
- Super durable corrosion resistant finish, black

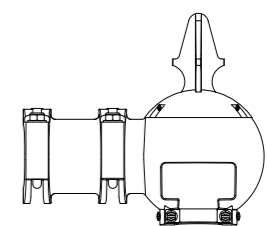



POLE TOP SHROUDS

RTR-1044-IW

- Covers and hides from sight radios attached to poles or other structures without interfering in radio performance
- DoITT-Approved and compliant design to NYC guidelines
- Fabricated from RF friendly material
- Tested from low frequencies up to 100GHz
- Suitable for concealing mmWave radios
- Features minimum dB loss
- PIM free tested per IEC 62037-8
- Thoroughly tested to validate no beam forming impact
- Hydrophobic surface
- Compatible with multiple radio/antenna configurations (mounts supplied per customer-specified combinations)
- Multiple color options available
- Easy to install
- Includes 5G radio bracket and antenna mount
- Includes pole mounting brackets
- Fans and controllers included
- Adjustable internal height is configurable to multiple radio/antenna configurations to allow for easy future expansion or equipment swaps

InvisiWave®
5G-READY SOLUTION



For Samsung NR AU Radios

REM-5470

- Complete solution for Samsung 5G NR AU radios
- Through bolted connection style; alternative connection types available for different pole styles
- Accommodates all small cell 4G canister antennas and Samsung 5G NR AU radios
- Variable pole diameter – attaches to most common sizes
- All structural steel hot dip galvanized per ASTM A123 with optional powder-coated finish to customer color specification
- Optional RCS-5128 antenna cable shroud for 5G radios*
 - Provides cable concealment and protection
 - Fabrication fit to radio used
- Fabricated from RF friendly, mmWave friendly material
- Tested from low frequencies up to 100GHz with minimum dB loss
- Thoroughly tested to validate no beam forming impact
- PIM free tested per IEC 62037-8
- Hydrophobic surface
- Easy to install
- Multiple color options available



CABLE SHROUDS/RADIO MASKS

RCS-2201202-01-X

- InvisiWave 5G mask for Samsung AT1K0x and E/// 6705, 6701, 1652 radios
- Thermal analysis designed passive ventilation
- Compatible with OEM mounts or Raycap mount sold separately



RCS-21147

- InvisiWave 5G radio mask for Nokia AEUB, Samsung ATK, and E/// 6701 radios
- Thermal analysis designed passive ventilation
- Compatible with OEM mounts or Raycap mount sold separately



RCS-2100028-00

- Composite cable beard for E/// 1281 only
- Compatible with OEM mounts or Raycap mount sold separately



RCS-21133

- Composite cable beard for E/// 6701 only
- Compatible with OEM mounts or Raycap mount sold separately



RCS-2001539-00

- Composite cable beard for Samsung AT1K radios
- Compatible with OEM mounts or Raycap mount sold separately



RCS-2100232-00

- Composite cable beard for Nokia AEUB radio
- Compatible with OEM mounts or Raycap mount sold separately

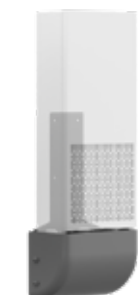

RCS-2000909-02

- 12.75" wide stainless steel cable beard for Amphenol panel antenna
- Note this is not compatible with all Amphenol models
- Antenna specifications must be verified prior to ordering



RCS-2102254-00

- 20" wide composite cable beard for macro panel antennas
- Mounts to antenna mounting pipe (2" - 5" STD pipe)



MID-POLE SHROUDS

Composite Shrouds

DOITT Side Mounted Shrouds

Raycap's non-metallic shroud was explicitly designed for the New York City (NYC) metro area. In some locations, installation on the ground is not possible. Whether due to lack of space, permit restrictions or even a costly installation of power and/or fiber cables for the connectivity, this scenario requires installing active equipment (antennas and connectivity enclosures) on or at the side of an existing structure. Raycap has developed several side-mounted solutions for existing light poles as well as additional wall mounted solutions. Single and multi-carrier configurations are successfully deployed throughout NYC using this solution.

- Compatible design to NYC guidelines
- Can support single or multi-carrier configurations
- Every configuration is accessible for thermal management
- Full in-house integration
- Computerized material tracking system tracks carrier's supplied components from their warehouse to our manufacturing/assembly facility to the installation site
- Improved intake louver design enables better circulation
- UL certified assembly
- PIM free tested per IEC 62037-8
- Easy installation
- Fabricated from RF friendly material
- Multiple color variations are available
- Made in the USA

Components

- Power and fiber management modules

DOITT Shroud (38" x 16" x 14")

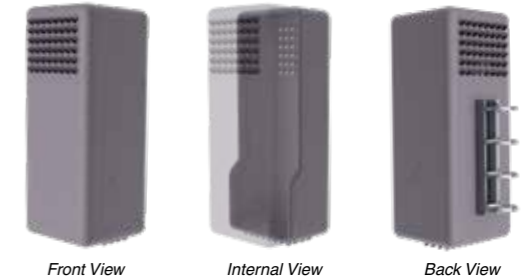

Front View

Internal View

Back View

DOITT Shroud (35" x 15.5" x 9")



Front View

Internal View

Back View

DOITT Shroud (40" x 24" x 18")



Front View

Internal View

Back View

5G Side Mounted Shrouds

RSE-21212

- Ergonomic design for easy radio installation and replacement
- Covered with InvisiWave mmWave friendly material
- InvisiWave is tested per UL 746C and meets requirements of an f1 rated material, suitable for outdoor use
- Entire solutions thermally tested according to GR-487
- Includes fiber and power management
- Offset bracket to minimize signal blockage components
- Supports various configurations





POLE MOUNTED METALLIC SHROUDS

Quality telecom equipment enclosures to support any requirement

Raycap pole-mounted telecom enclosures and cage shrouds accommodate 4G/5G open access (Open RAN) and distributed antenna (DAS) network equipment.

Available in different styles, they enable various OEM equipment to be easily mounted in the same cabinet.

Our pole-mounted telecom cabinet solutions are made from aluminum and feature an aesthetic and lightweight modular design strong enough to support a variety of equipment while enabling passive heat dissipation.

We have a large variety of specialized telecom enclosure solutions in various sizes. Contact us for more product information and a solution to fit your needs.

Series 1

- Accommodates a variety of radios
- Features a fiber box and a power supply
- Radios are supported on the middle frame in a back-to-back configuration
- Individual brackets are supplied for specific products
- Attachment points on the center frame structure
- Available with a rectangular or curved door.
- Optional AC disconnect with Strikesorb surge protection.

Series 2

- Accommodates a variety of radios
- Features a fiber box and a power supply
- Radios are supported on a frame at the back in a fixed configuration
- Individual brackets are supplied for specific products
- Attachment points on the back frame structure
- Available with a rectangular or curved door.
- Optional AC disconnect with Strikesorb surge protection.

Series 3

- Accommodates a variety of radios
- Features a fiber box, power supply, and other optional equipment
- Interior products mount on peg board style backplane
- Multiple attachment point options enable flexible equipment configurations
- Future-proof design allows for easy removal or addition of equipment
- Cabinet doors are removable in the field and can be replaced with more oversized doors
- Optional add-on fan tray.
- Optional AC disconnect with Strikesorb surge protection.

Additional available cabinet components

- AC disconnect
- Attachment points on the center frame structure
- Available with a rectangular or curved door.

Optional AC Disconnects

Common and Standard Features

- Suitable for Use as Service Equipment (SUSE) with NO condition per UL and NEC
- 60A or 100A main breaker, 10kAIC
- 120/240 VAC
- Up to 24 circuits available
- Strikesorb 30-A-2CHV SPD (L1-N, L2-N)
- Available in a powder coated (multiple colors options) or in a polycarbonate enclosure
- Rigorous weatherproof enclosure options: NEMA 4 (for hose down/sprinkler protection), NEMA 4x (for corrosive locations), and even NEMA 6/6p (IP68) for temporarily submerged locations like street hand holes
- Lockout Tag out (LOTO) functionality
- Versatile mounting bracket included



See pages 55 – 59 for details

Series 1



RSCAC-1028-DY4

Series 2



RSCAC-1029-DY4

Series 3



RCAB-6821-XYZ



4G + 5G WOOD POLE TOP MOUNTS

RTR Series

- Accommodates all small cell 4G panel antennas through various adapter plates
- Variable pole diameter – attaches to most common sizes
- All structural steel powder-coated galvanized finish to customer color specification
- PIM free tested per IEC 62037-8
- Included bubble-level assists in precise and easy installation
- Universal wood pole base or custom metal pole base available
- Each unit ships with the RTR-Series Universal Top-Mount Base

RTR Series Universal



RTR-FG-TRBR

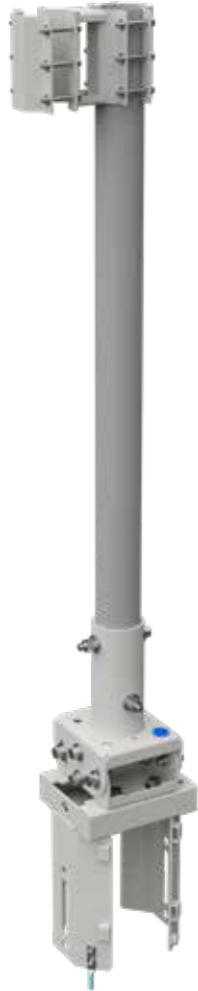

RTR-TRBR



RTR-5G-CM



RTR-CMM-NT



RTR-CMM



RTR-FXG

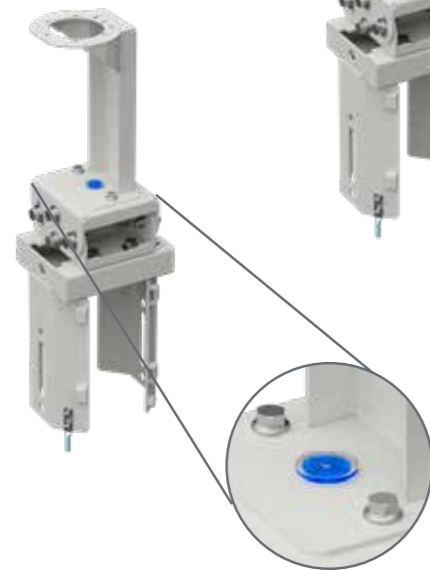

Leveling Bubble Included

4G + 5G WOOD POLE SIDE MOUNTS

RSM Series

RSM-Series Universal



Also available with fiberglass tube extension to support ConEdison specifications.

RSM-CMM



Leveling Bubble Included

RSM-FXGL

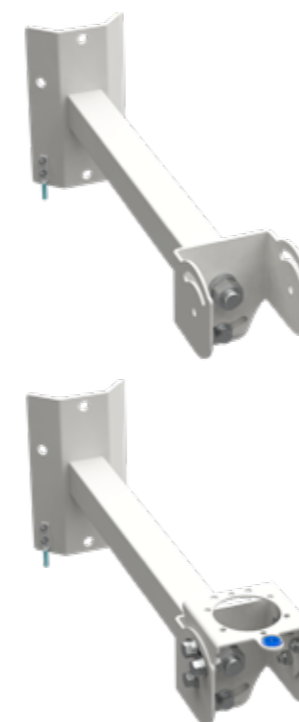

RSM-CMM-PA



4G+5G WOOD POLE MODULAR COMPONENTS

Our modular series offers nearly endless combinations that can be made with a set of modular components. Available options are not limited to the following pre-built assemblies, which are intended to inspire. All common OEMs are supported.

Please inquire with any specific requests.

- The modular system can be employed to fit almost any custom equipment configuration.
- Accommodates all 5G mmWave radios or small panel, whip, or canister 4G antennas.
- Variable pole diameter – attaches to most common sizes
- All structural steel hot dip galvanized per ASTM A123 with optional powder coated finish. See Appendix for available colors.
- Integrated leveling is provided in three axes for all technologies, and bulls-eye leveling dots are included.

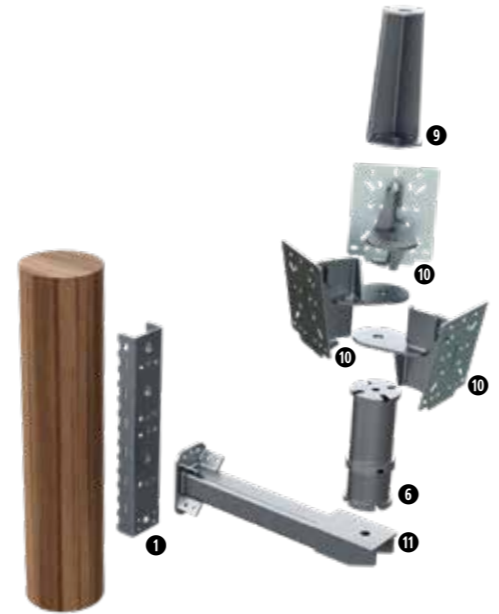

RSM-M-22227 4G & 5G Tall Leg Side Mount Exploded View

Modular Components

Connection to Pole

- 1 M-22922 Base component for most topper and side arm assemblies, two universal mounting patterns
- 2 M-22080 Base component, single universal mounting pattern
- 3 M-22780 Triple clamp assembly, 7" diameter poles



Leveling

- 4 M-22062 Light duty leveling for omni-directional whip and canister antennas, up to 5° in any direction
- 5 M-22231 Heavy duty leveling assembly, tall, extra clearance for large 5G radios, up to 10° in any direction
- 6 M-22436 Heavy duty leveling assembly, compact, up to 10° in any direction



Equipment Mounting – Radios And Antennas

- 7 M-22643 Whip antenna mount, bolt
- 8 M-22047 Whip antenna mount, clamp
- 9 M-22858 Omni-directional canister antenna mount
- 10 M-22078 Radio mounting bracket, 10° downtilt, 5° uptilt, supports all major radios



Side Arm Options

- 11 M-22193 Side arm, single-bolt pattern
- 12 M-22291 Side arm extension, universal mounting pattern



Adapter/Extension Brackets

- 13 M-22925 Converts between the universal mounting pattern and single-bolt mount pattern
- 14 M-22585 90° universal mounting pattern adapter, also supports single-bolt pattern
- 15 M-22774 Provides two additional universal mounting locations
- 16 M-22919 For bridging between two legs (M-22922) to support a large topper assembly



Single Leg

Options are for light-duty installations, down to 5.5" diameter poles. Mounts via thru-bolts and/or straps

RTR-M-22523

Single Whip Antenna



RTR-M-22092

Whip and Single Elevation of 5G



RTR-M-22148

Canister and 5G



Dual Leg

These options support more and larger equipment and up to 13" diameter poles. Mounts via thru-bolts and/or straps.

RTR-M-22783

Canister and 5G Above Pole



RTR-M-22238

5G Elevated Above Pole



RTR-M-22336

Canister and 2 Elevations of 5G



4G + 5G WOOD POLE MODULAR COMPONENTS

Triple Clamp

Feature clamping with additional thru-bolt option. Fits 7" - 13" diameter poles.

REM-M-22081

5G Triple Clamp Assembly

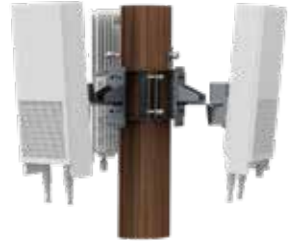

REM-M-22244

Omni-mount Triple Clamp Assembly



Tall Bracket

With side arm – thru-bolt and/or strap mounting, side arm available in multiple lengths.

RSM-M-22162

5G Side Mount



RSM-M-22291

5G Side Arm Mount



RSM-M-22227

4G & 5G Side Mount



Short Bracket

Mounts via thru-bolts and/or straps.

RSM-M-22815

Single 5G Radio



RSM-M-22487

5G Side Mount Low Profile



Double Sided

Equipment mounted on both sides of the pole, thru-bolt and/or strap mounting.

RSM-M-22844

Dual 4G & 5G Side Mounts



4G + 5G WOOD POLE EXTENSION MOUNTS

RATM-211501-A

- 4G/5G wood pole solution
- Supports various pole ODs
- Fiberglass extension
- Tri-sector mmWave radio mounts with downtilt shown with Samsung AT1K radios



RATM-211501-ST

- 4G/5G wood pole solution
- Supports various pole ODs
- Fiberglass extension
- Dual-sector mmWave radio mounts with downtilt shown with Nokia AEUD/E radios



Raycap's line of 4G+5G specialized extension mounts for wood poles provides excellent mounting solutions for various radios or antennas.

COMPLETE SIDE-MOUNTS

Our complete side-mounted hardware series enables the easy mounting of radio and antenna systems to the sides of wood or steel poles.

REM-3099

- Side arm mount for 4G Omni and supporting radios
- 5G radios may be banded to the pipe mast as shown with Nokia AEUD/E
- Can be strapped or thru-bolted to wood or steel poles



REM-1348

- Side mounted enclosure for (3) E/// 220x radios
- Fully concealed 4G Omni within radome
- Can be strapped or thru-bolted to wood or steel poles



RSM-4651-5

- Side mounted enclosure for (3) E/// 220x radios
- Elevated radome for 5G radios mounting as shown with E/// 1281
- Can be strapped or thru-bolted to wood or steel poles



RSM-20247

- Side mount frame for 4G Omni and supporting radios
- 5G radios may be banded to the pipe mast as shown with E/// 1281
- Can be strapped or thru-bolted to wood or steel poles



GALVANIZING, POWDER COATING & PAINTING

Our state-of-the-art automated powder-coating booths and painting facilities are together under one roof, with our powder-coating booths for wash, dry-off, and application capable of accommodating up to 42-foot poles, with dual ovens operating for maximum productivity. In addition, we contract the galvanizing process to local, long-standing partners who pay close attention to accelerated deadlines. Our efficiencies provide economy and help us to slice time to market from customer jobs without sacrificing quality. Highly experienced production personnel, many with years of tenure in the company, understand the high-quality standards needed to ensure Raycap customers are always delighted with every outcome.



ARTIST PAINTING

An important part of the concealment business is matching an existing texture, color value, or hue to blend seamlessly into any environment. Our custom artist shop is an invaluable resource to our customers, helping them to achieve suitable material treatments, color matches and textures to give the desired effect. Customers use our artist-created Color Match Tool to photograph the closest match to whatever surface must be recreated, then send it back to us. Then our team presents the best solution to meet and exceed any project requirements.



1	2	3	4	5	6	7	8	9	10	11	12	13	14	15	16	17	18	19	20	21	22	23	24	25	26	27	28	29	30	31	32	33	34	35	36	37	38	39	40	41	42
<p>Raycap Color Match Tool</p> <p>Company: Your Name: Site Name: Date:</p> <p>Photography Instructions:</p> <ul style="list-style-type: none"> • Use no flash • Position the color tool flat to the surface using tape • Photograph at a distance of 15' • Photograph repeating patterns and surface dimensions with a visible tape measure • Photograph physicals at the site of extraction 																																									

LASER & PLASMA CUTTING

Our laser and plasma cutting capabilities are extensive, unique, and designed to help us produce customer materials quickly and effectively on time and budget. The laser cutter is a workhorse capable of cutting up to 1" thick material in a 5' x 10' sheet. Our plasma cutter can cut 10' x 20' sections of up to 2.5" thick, while our pipe plasma machine is capable of producing custom pipes up to 1.5" thick, 42' long, and up to 24" in diameter.



FORMING & ROLLING

Our capabilities include the rolling, forming, and bending of steel to support our customers' small cell pole needs. Steel poles are formed and bent to accommodate light arms and other pole attachments. In addition, metal forming and rolling are used to produce decorative bases, metal fluting, cable shrouds, and more.



WELDING

Raycap's welders deploy many processes and a wide range of welding techniques. The capabilities of our highly skilled fabricators can be seen in the many diverse custom-designed small cell pole concealment configurations made to meet operator and municipality requirements.



ASSEMBLY

Many Raycap products are custom-built for unique customer applications and to their specifications. There is a high level of vertical integration in our products and their core elements to adapt the manufacturability and assembly of product lines based on the needs of our customers.

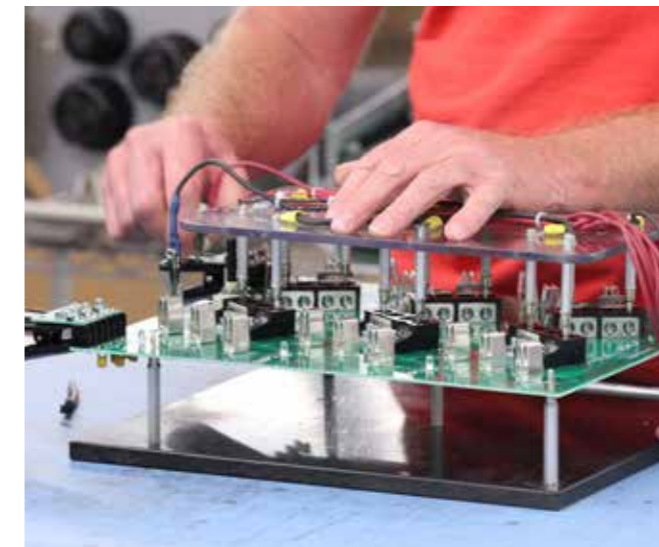

SMALL CELL POLE PHOTO GALLERY



POLE TOP SHROUDS PHOTO GALLERY

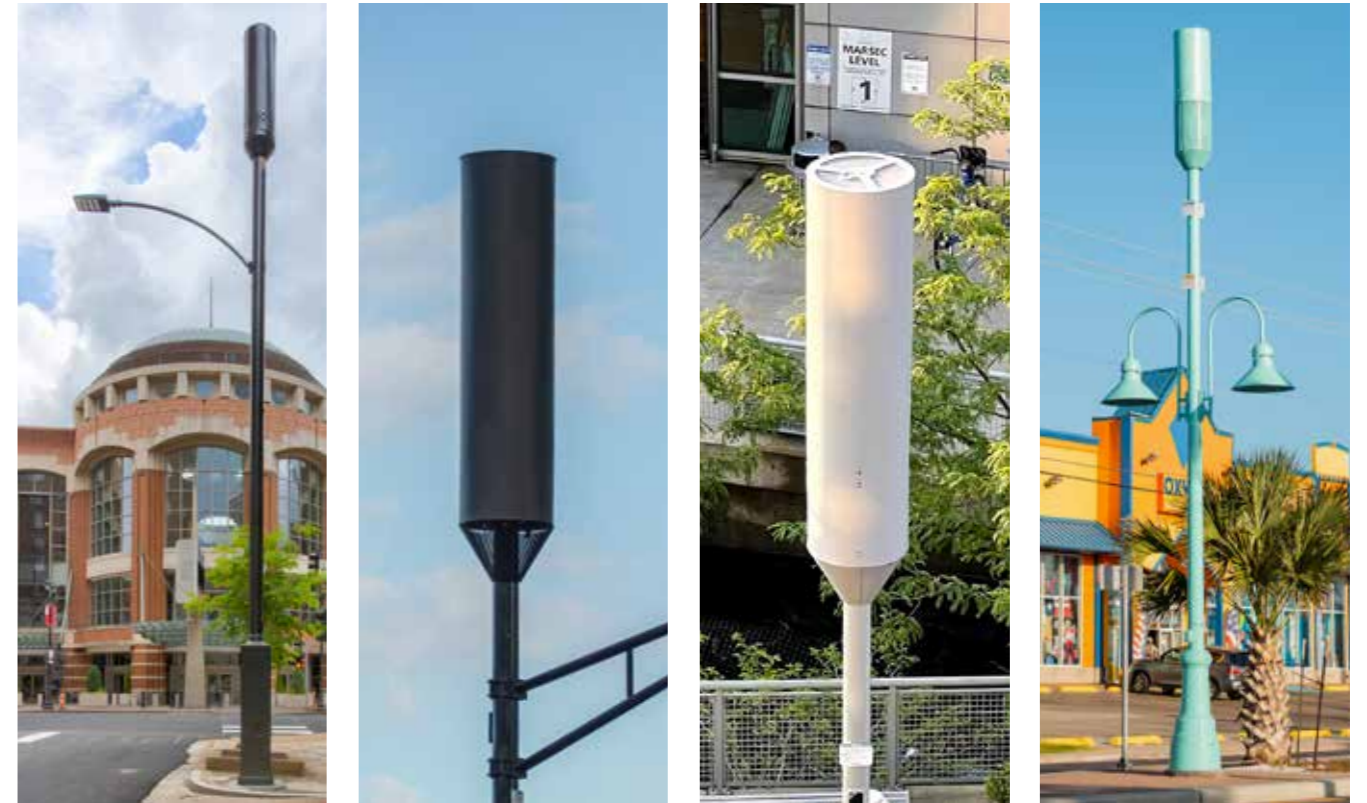



POWER MANAGEMENT SOLUTIONS

Strikesorb® SURGE PROTECTION

Raycap is the Trusted Name in Advanced Surge Protection Solutions for Mission-critical Cell Site Applications

Raycap is the technology leader in the development of advanced surge protection components and systems. Our goal is to continuously advance our technologies and develop solutions based on them to serve the needs of our customers.

For more than 20 years, we have continued to evolve the performance and design of our Strikesorb surge protection technology, increasing its capabilities while reducing its footprint. Strikesorb is a key component of the systems we engineer for wireless cell sites and is deployed on cell tower tops, rooftops, base stations, and in small cell sites worldwide. Our Strikesorb 30 2CHV surge protection device is purpose-built for telecom power applications and is available in two variations, a 30-V1-2CHV for DC power protection and a 30-A-2CHV for AC power protection. Both designs combine two protection modes in one compact package, offering excellent protection while saving space in the enclosure, an important development for space-restricted cell site architecture.

Each Strikesorb protection mode incorporates a single, heavy-duty, distribution-grade Metal Oxide Varistor (MOV) disk assembled under pressure in an environmentally sealed aluminum casing. This unique design provides very low internal contact resistance, excellent thermal management, and uniform distribution of the surge current over the total area of the protection element, resulting in an extremely high energy handling capability combined with very low let-through voltage.

Strikesorb's design minimizes the effects of aging and completely eliminates the risk of catastrophic failure, explosion, or fire, common in conventional surge protective devices relying on internal fuses and thermal disconnectors. In addition, our products are designed to withstand repeated surges, ensuring uptime and providing cost-effective, maintenance-free operation in harsh environments.

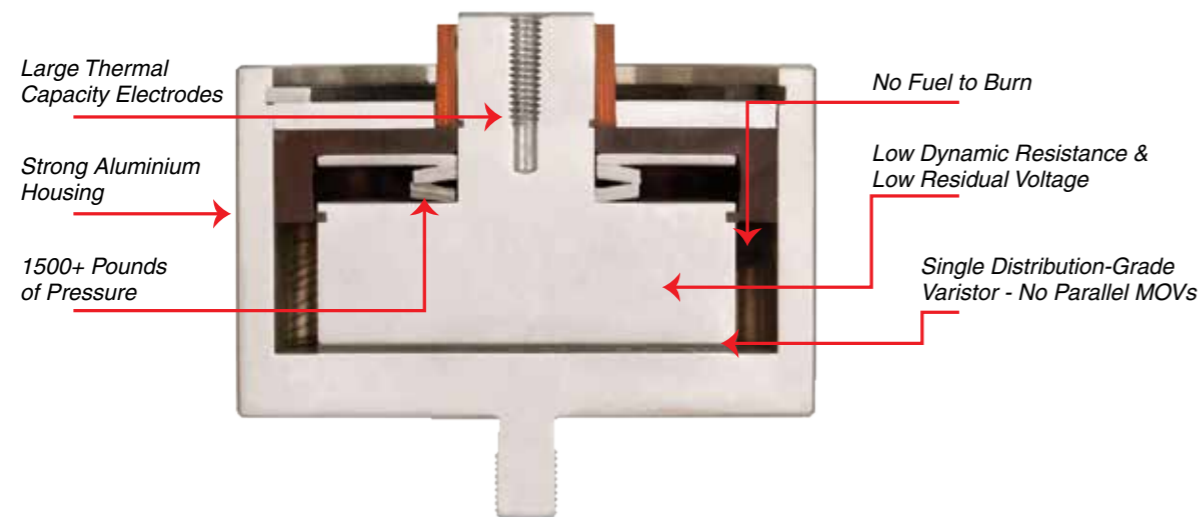

Shown: Strikesorb 80

Requirements for Surge Protective Devices (SPD) For Use in Cell Site Applications

Able to withstand lightning currents

The surge protective device (SPD) will be exposed to locations where it must withstand lightning currents following a 10/350 waveform. Therefore it must have the protection level of a Class I SPD according to IEC 61643, and Type 1 per UL 1449 5th Edition. Strikesorb's Class I+II surge protective devices are designed specifically for the DC power environments of telecom infrastructure.

Continuous and efficient protection of the equipment

Under any condition, the SPD should always protect the equipment. This means that it should not disconnect itself from the power lines to self-protect, leaving the equipment unprotected. Further, it should provide a very low protection level (let-through voltage) that protects the critical electronic equipment efficiently, maintaining it in good condition over its expected lifetime.

Long lifetime

The SPD should have a long lifetime and never fail, even in harsh lightning environments, where exposure to direct lightning is much higher than average. Strikesorb products have a ten year product warranty, and many have been in the field for over 20 years. The product's unique design dissipates heat and eliminates the aging problems found in conventional SPDs.

Optimized solutions

The SPD line should be optimized in terms of available size, cost, and specification according to the requirements of the installation. Raycap's Strikesorb is purposefully designed to be the premier protection of DC power in cellular sites, while AC power protection versions meet the needs for protecting the grid-side power.

Maintenance-free and safe operation

In cell site applications, the SPD should not have to be inspected or replaced, as this requirement will result in increased field maintenance costs. It also must be certified to the UL 1449 5th Edition standard for safe operation because it must not explode or catch fire in the case of a high power surge. Strikesorb meets all international safety requirements (without the need for an internal or external fuse) and it is capable of taking numerous lightning surges without failing.



METERBASE & AC DISCONNECTS

RMx-E2 Series

The product offers a tightly integrated ringless meterbase and AC Disconnect functionality in one narrow enclosure (only 9.5" wide) to better blend into the environment when pole-mounted.

- Suitable for Use as Service Equipment (SUSE) without condition per UL and NEC with 60A or 100A main breaker
- Up to twelve circuits for individual power control and over current protection
- Comes standard with either (12) or (2) DIN rail 13mm breakers providing (12 or 2) 120VAC circuits which can be bridged to provide (6 or 1) 240V feeds
- 120/240VAC split-phase or 2 of 3 phases from 208Y/120VAC configuration
- Available surge protection
Strikesorb 30-A-2CHV Surge Protective Device (SPD)
 - Class I SPD, certified by VDE per the IEC 61643-11 standard as suitable for installation in areas where induced lightning exposure is expected
 - Withstand direct surge currents up to 5kA (10/350µs) and induced surge currents of up to 60kA (8/20µs)
 - Low let through / clamping voltage - as it does not employ spark gaps or other switching elements
- Lockable front hatch access to the main breaker (optional).
- Main power can be turned on and off without opening the main enclosure door. Lockout Tagout (LOTO) functionality.
- Flexible mounting options for walls, poles or H-Frames
- Top, bottom, side or rear cable entry allows for cleaner, more flexible installations
- Patent pending design



AC Disconnects

The RSCAC and RSx-Series are 120/240VAC industry standard load centers and surge protection devices that are suitable for use as service equipment (SUSE) without condition per UL and NEC. They are designed to provide robust overvoltage surge protection for the AC power circuits for today's small cell radio systems. They employ Strikesorb 30-A-2CHV modules capable of withstanding direct surge currents up to 5kA (10/350µs) and induced surge currents up to 60kA (8/20µs). These products provide dual (L1 to N) (L2 to N) protection for up to 16 AC circuits depending on the model.

Common and Standard Features

- Suitable for use as Service Equipment SUSE with without condition per UL and NEC
- 120/240VAC, up to 100A installations
- Load breakers can be 2A - 25A rated (RSx-Series) or 15A and 20A tandems (RSCAC-Series)
- Tightly integrated AC disconnect, AC distribution and AC surge protection in one cabinet
- Strikesorb overvoltage protection (OVP) on AC circuits
- Ruggedized industrial construction, most with top and bottom cable access for maximum flexibility and space-savings in small cell deployments
- Rigorous weatherproof enclosure options: NEMA 4 (for hose down/sprinkler protection), NEMA 4x (for corrosive locations), and even NEMA 6/6p (IP68) for temporarily submerged locations like street hand holes
- Optional AC GFI protected outlet and/or various means of external disconnects are available on some models



RSD-FMC-Z16MS-21NN
(16 Breakers, Strikesorb SPD, External Disconnect)

AC DISCONNECTS

RSx-D Series

- 60A or 100A main breaker, 10kAIC
- Top, bottom, side cable access
- Ships with 2 to 10 breakers
- 13.87"H x 9"W x 6"D



RSD-DMN-X10MS-21NN

RSx-E Series

- 60A or 100A main breaker, 10kAIC
- Top, bottom, side cable access
- Ships with 2 to 12 breakers
- 14.87"H x 9"W x 6"D



RSD-EMN-Z12MS-21NN

RSx-F Series

- 60A or 100A main breaker, 10kAIC
- Top, bottom, side cable access
- Ships with 2 to 16 breakers
- 18.5"H x 9"W x 6"D



RSD-FMN-Z16MS-21NN

RSx-T Series

- 100A main breaker, 10kAIC
- Top, bottom, side cable access
- Ships with 24x 1-Pos, 12x 2-Pos or other combination of din-rail breakers (2A to 25A)
- 22.59"H x 9"W x 6"D



RSD-TMC-Z24MS-21NN
(Lt. Gray color, 24 Breakers, Strikesorb SPD, External Disconnect)



RSD-DML-Z10MS-21NN
(Lt. Gray color, 10 Breakers, Strikesorb SPD, External Disconnect)



RSD-EML-Z12MS-21NN
(Lt. Gray color, 12 Breakers, Strikesorb SPD, External Disconnect)



RSD-FMC-Z16MS-21NN
(Lt. Gray color, 16 Breakers, Strikesorb SPD, External Disconnect)

Common and Standard Features

- Suitable for Use as Service Equipment (SUSE) with NO condition per UL and NEC
- 60A or 100A main breaker, 10kAIC
- 120/240 VAC
- Up to 24 circuits available
- Strikesorb 30-A-2CHV SPD (L1-N, L2-N)
- Metallic enclosure, NEMA 4
- 9"W x 6"D (Height depends on breakers)
- NEMA 4 powder coated enclosure, available in multiple colors
- Lockout Tag out (LOTO) functionality
- Versatile mounting bracket included

RSa-bMc-deMS-21NN

a: RAL color		b: Enclosure Series		c: LED & Ext. Disconnect		d: Main Breaker		e: # of Breakers	
D	= Light Gray / RAL7047	D	= 13.87" H, up to 10 Breakers	N	= Internal Disconnect Only	X	= 60A Main Breaker	02	= 2 Breakers
G	= Green / RAL6012	E	= 14.87" H, up to 12 Breakers	C	= External Disconnect	Z	= 100A Main Breaker	10	= 10 Breakers
B	= Black / RAL9011	F	= 18.5" H, up to 16 Breakers	L	= LED and External Disconnect			12	= 12 Breakers
N	= Brown / RAL7013	T	= 22.59" H, up to 24 Breakers					16	= 16 Breakers
L	= Blue / RAL5022							24	= 24 Breakers

AC DISCONNECTS

RSCAC-1333 Series

- 60A main breaker
- 22kA Fault Current Rating (kAIC)
- 6x configurable tandem breakers provided (12 Loads)
(Default is 6x 15A/15A tandem breakers. Custom breaker lists can be specified at the time of order.)
- Bottom cable access
- 9"H x 9"W x 5"D
NEMA 4X or IP 68 and NEMA 6/6P rated enclosure
- Versatile mounting bracket included



RSCAC-1333-P-240



RSCAC-1333-P-240-D
– Hinged-Cover
External Disconnect



RSCAC-1333-PH-240
– No-hinge front door
for concealment or
pole applications
– Submersion up to
1 meter for 30 minutes

RSCAC-9556 Series

- 100A main breaker
- 22kA Fault Current Rating (kAIC)
- 6x configurable tandem breakers provided (12 Loads)
(Default is 6x 15A/15A tandem breakers. Custom breaker lists can be specified at the time of order.)
- Bottom cable access
- 11"H x 9"W x 5"D
NEMA 4X or IP 68 and NEMA 6/6P rated enclosure
- Versatile mounting bracket included



RSCAC-9556-P-240



RSCAC-9556-P-240-D
– Hinged-Cover
External Disconnect



RSCAC-9556-PH-240
– No-hinge front door
for concealment or
pole applications
– Submersion up to
1 meter for 30 minutes

RSCAC-9550 Series

- 60A main breaker
- 22kA Fault Current Rating (kAIC)
- 6x configurable tandem breakers provided (12 Loads)
(Default is 6x 15A/15A tandem breakers. Custom breaker lists can be specified at the time of order.)
- Top and bottom cable access
- 11"H x 9"W x 5"D
NEMA 4X or IP 68 and NEMA 6/6P rated enclosure
- Versatile mounting bracket included



RSCAC-9550-P-240



RSCAC-9550-P-240-D
– Hinged-Cover
External Disconnect



RSCAC-9550-PH-240
– No-hinge front door
for concealment or
pole applications
– Submersion up to
1 meter for 30 minutes

RSCAC-7038 Series

- 100A main breaker
- 10kAIC System Rating (due to GFI)
- 6x configurable tandem breakers provided (11 Loads + GFI)
(Default is 6x 15A/15A tandem breakers. Custom breaker lists can be specified at the time of order.)
- Top and bottom cable access
- 14"H x 9"W x 5"D
NEMA 4 rated enclosure
- GFI convenience outlet



RSCAC-7038-P-240



RSCAC-7038-P-240-D
– Hinged-Cover
External Disconnect



RSCAC-7239 Series

- 100A main breaker
- 22kAIC System Rating
- 6x configurable tandem breakers provided (12 Loads)
(Default is 6x 15A/15A tandem breakers. Custom breaker lists can be specified at the time of order.)
- Top and bottom cable access
- 14"H x 9"W x 5"D
NEMA 4 rated enclosure



RSCAC-7239-P-240



RSCAC-7239-P-240-D
– Hinged-Cover
External Disconnect



RBx-EMC-X10MS-21L6

- 60A main breaker, 10kAIC
- Ships with 10 pre-populated breakers
- BLACK IP66 enclosure
- Top, bottom, rear cable access
- 3x RJ45 connections
- 13.87"H x 9"W x 6"



RBx-EMC-X10MS-21L6
– Hinged-Cover
External Disconnect



MOUNTING PEDESTALS WITH AC DISCONNECTS

RPDx-PA Series Mounting Pedestals

- Clean, consistent appearance for meterbase and site disconnect/distribution functionality
- Universal back-panel design accepts all utility-approved meterbases
- Strong and durable powder coated metal construction includes flexible mounting-base for easy installation
- Available in different colors to meet jurisdiction requirements
- Overall height (Above Grade Level) of 72.5" accommodates full range of approved meter-face heights
- Allows flexible and unobtrusive access for utility-input and load-output conduit runs
- Pre-integrated assembly saves time and money during installation

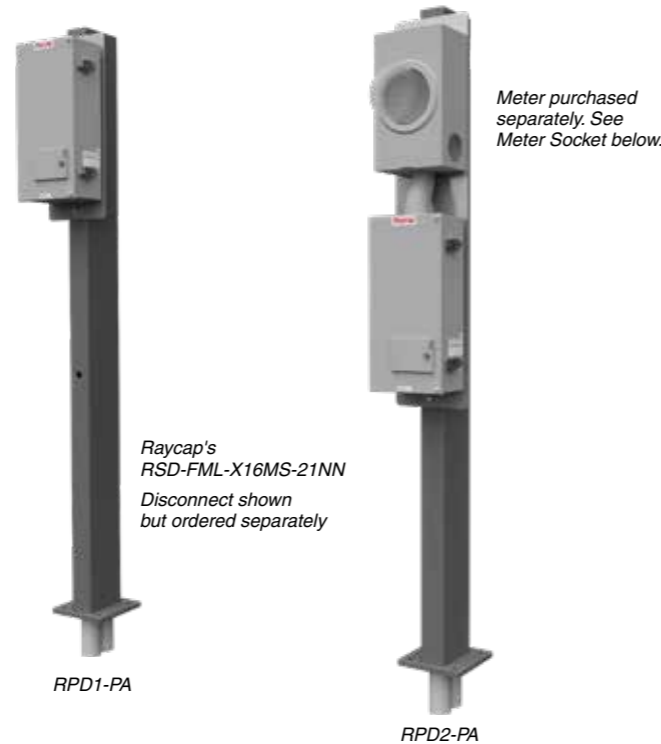

METER SOCKET

RMS-BL5-DPE

- 200 amp service connections
- Slim form factor
- Ringless style meter base
- Stainless steel swinging style locking latch
- 4/0 aluminum service wire
- Clean, consistent appearance for meterbase and site disconnect/distribution functionality
- Strong and durable powder coated metal construction includes flexible mounting-base for easy installation
- Available in different colors to meet jurisdiction requirements
- Allows flexible and unobtrusive access for utility-input and load-output conduit runs



AC/DC COMBO POWER MANAGEMENT

RUSAC-1440-P-240

- 60A main breaker
- DC power supply capable of providing up to 600 Watts at -54 VDC
- (2) 15A DC outputs
- Employs the Strikesorb 30 Series Surge Protective Device (SPD)
- Passive or active cooling
- Indicator LEDs for AC available and DC available
- NEMA 3R rated enclosure suitable for outdoor



RUSAC-1AN2-P-240-1

- 100A main breaker
- 120/240 VAC split phase configuration
- Up to six branch breakers providing (6) 120VAC circuits or (3) 240VAC circuits.
- Employs the Strikesorb 30 Series Surge Protective Device (SPD)
- DC power supply capable of providing up to 2000 Watts at -54 VDC (expandable to 4000 Watts)
- Externally visible indicator available for AC and DC
- Over current protection for up to 6x AC circuits and up to 4x DC circuits for customer use
- Air-to-air heat-exchanger maintains closed loop NEMA Type 4 environment for equipment. Prevents ingress of contaminants and moisture.



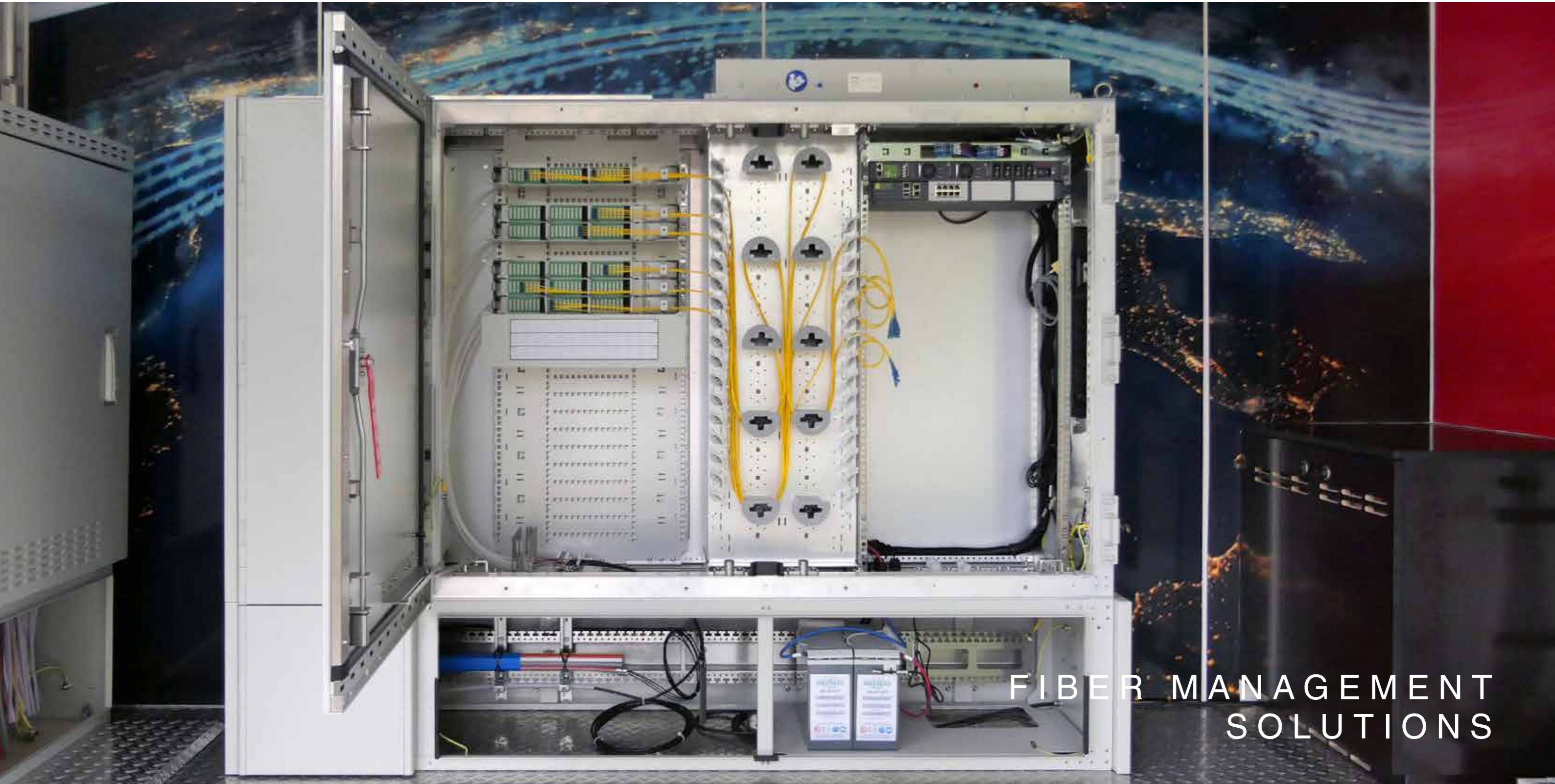

FIBER MANAGEMENT
SOLUTIONS

FIBER ENCLOSURES

Raycap offers pole or wall mount fiber enclosures for indoor and outdoor use. They are specifically designed for fast deployment and easy customer connection, providing the ultimate flexibility and optimal fiber organization.

- Lightweight design
- IP65 sealing rate
- Minimum bending radius protection 30mm
- Customized configuration capacity available
- Allows integration of passive optical components
- Wall and pole mounted
- UV stable material for outdoor above ground use
- Passive convection cooling
- The standard kit contents include wall mounting brackets and splice protector sleeves
- Optional installation of 6 PLC splitters (PLC splitters are pre-connectorized only on the outputs.) Customization is available.

RTF-8028

- Splicing capacity of 8 fibers



RTF-3018

- Splicing capacity of 2 fibers



RTF-7054

- Splicing capacity of 4 fibers



RTF-3392

- Splicing capacity of 16 fibers



RTF-3116

- Splicing capacity of 12 fibers



RTF-5238

- Splicing capacity of 6 fibers



RTF-8818

- Splicing capacity of 24 fibers



FIBER CABINETS

Raycap offers pole, ground or H-Frame mount Fiber Demarcation enclosures for outdoor use. They are designed to be easily deployed, easily upgraded and easy to maintain.

APRANE-227116-x

- Fully customizable
- Field upgradable & replaceable cooling options
- Several RU options
- NEMA-3R/4X
- Powdercoated galvanized aluminum
- Integrated Strikesorb surge suppression available
- Readily available
- Integration available

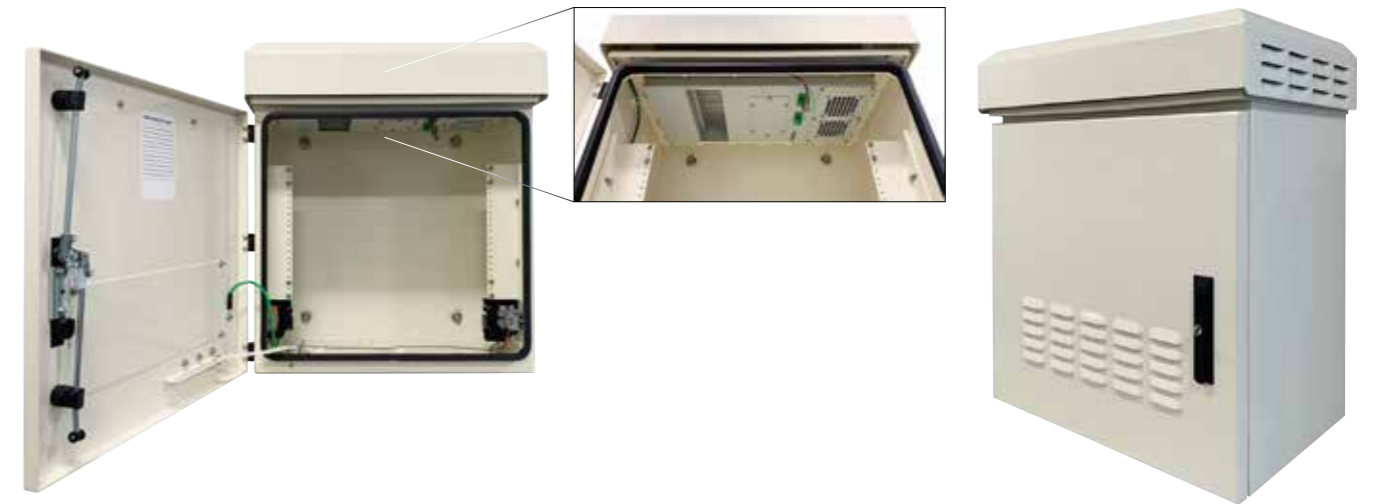

RCF-2102078-00

- Aluminum construction 47" x 28" x 21"
- Robust and modular design
- Easy installation process
- Panel banded technology
- 120° door opening
- Up to 288 fibers out
- Supports LGX modules
- 64 LC parking positions
- Excellent fiber management





SPECIALIZED
CONCEALMENT SOLUTIONS
& INDOOR DAS SYSTEMS

ROOFTOP SOLUTIONS

Product solutions covering rooftop small cell sites with a screen wall, chimney, pod, or cupola, are available from Raycap. Rooftop concealments complement existing construction, and hand-crafted faux brick, block, stucco, and stone textures seamlessly blend with buildings. Each small cell rooftop concealment is built based on specific needs, fully customized to fit the existing aesthetic.

Replica Antennas

Raycap's exclusive InvisiWave solution is approved for use at mmWave frequencies including 24GHz, 28GHz, and 39GHz, as well as being fully backwards compatible with all commonly used sub-6GHz frequencies.

- Fabricated from RF friendly material
- Tested from low frequencies up to 100GHz
- Suitable to concealing mmWave radios
- Features minimum dB loss
- PIM free tested per IEC 62037-8
- Thoroughly tested to identify beam forming impact
- Hydrophobic surface
- Compatible to back lobe mitigation techniques with use of upgrade kits
- Covers and hides from sight radios attached to poles or other structures without interfering in radio performance
- Easy to install
- Full range of heights and diameters available to meet virtually all concealment applications
- Compatible with 5G radios
- Patent pending design

RCM-3114-IW

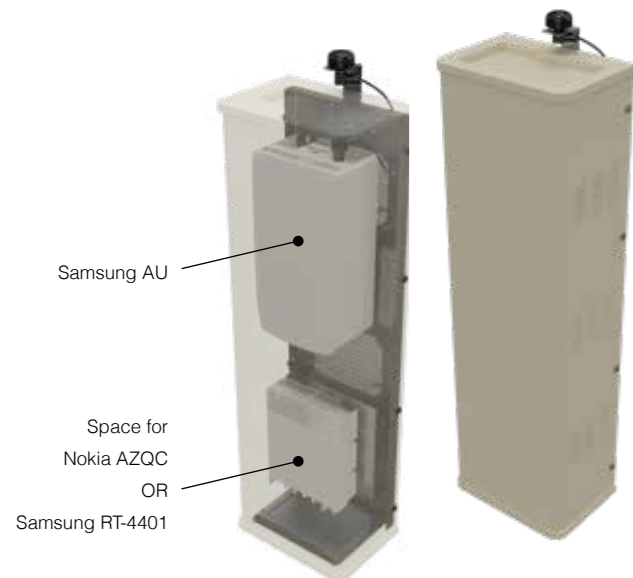

RCM-2496-IW

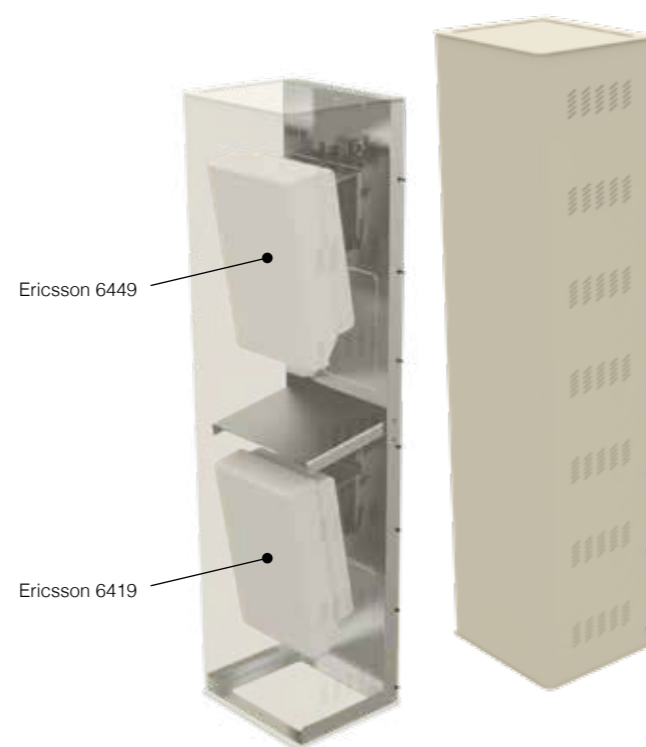

Rooftop Pods

RBM-21068, RBM-21090 and RBM-21108

- (3) size frame options; small, medium and large
- 36" OD radome up to 9' tall
- Maximum overall height of 14' tall
- Holds up to (6) radios and (1) OVP
- Allows pipe adjustment up to 10 degrees for roof slope

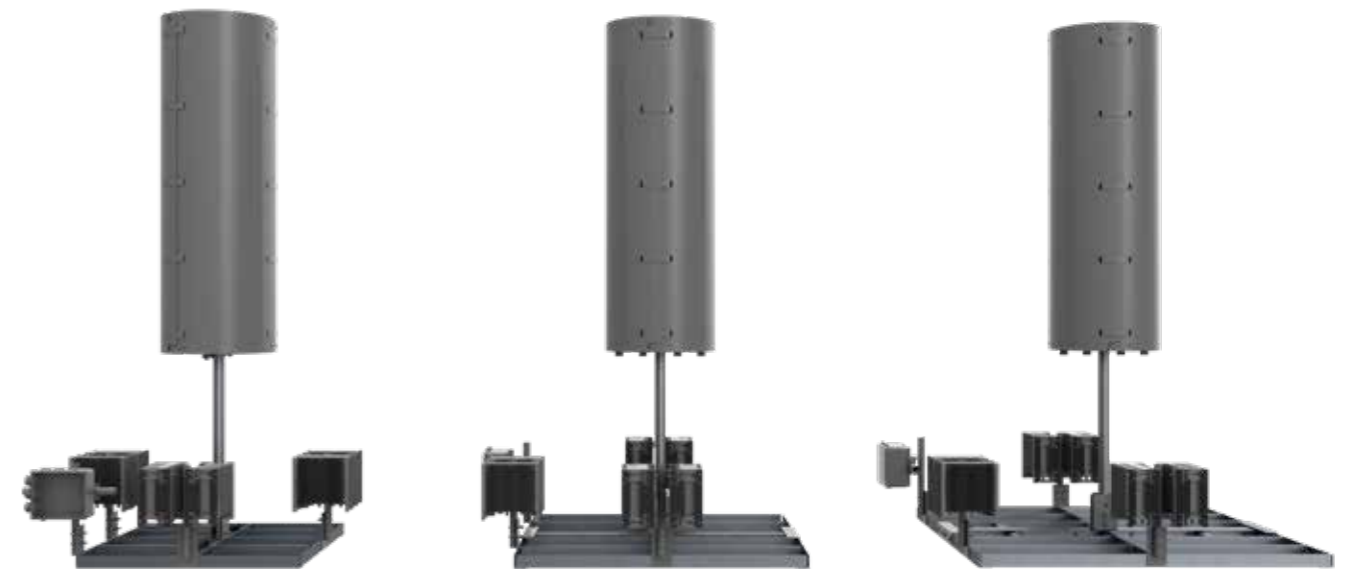

WALL MOUNTED SOLUTIONS

Product solutions covering rooftop small cell sites with a side-mounted box, pods, etc are available from Raycap. Wall mounted box concealments complement existing construction, and hand-crafted faux brick, block, stucco, and stone textures seamlessly blend with buildings.

Custom Shrouds

- Conceals small cell equipment
- Blends into any existing facility
- Round form factor shown; shrouds can be any shape including square, rectangular, or multisided
- Multiple operator and 5G mmWave InvisiWave versions are available



WALL & ROOFTOP SOLUTIONS GALLERY



SPECIALIZED CONCEALMENT



RESEARCH &
DEVELOPMENT

STANDARDS & CERTIFICATIONS

Steel Fabrication

- AWS D1.1 - Structural Welding Code - Steel
- ASTM A780 - Repair of Damaged and Uncoated Areas of Hot-Dip Galvanized Coatings
- AQL Level II where C=0

Galvanization

- ASTM A123 - Zinc (Hot-Dip Galvanized) Coatings on Iron and Steel Products

Powder Coating

- ASTM D523 - Standard Test Method for Specular Gloss
- ASTM D3359 - Standard Test Methods for Rating Adhesion by Tape Test
- ASTM D522 - Standard Test Methods for Mandrel Bend Test of Attached

Organic Coatings

- ASTM D3363 - Standard Test Method for Film Hardness by Pencil Test
- ASTM D2794 - Standard Test Method for Resistance of Organic Coatings to the Effects of Rapid Deformation (Impact)
- SSPC-SP1 - Solvent Cleaning
- SSPC-SP2 - Hand Tool Cleaning
- SSPC-SP3 - Power Tool Cleaning

UL Listings

- UL Listed Luminaire Poles – E483273
- UL Listed Cabinets and Cutout Boxes – E482338
- UL Listed Meter Sockets – E520977
- UL Listed Switchboards, Dead-Fronts – E248004
- UL 50: E482338, E487751
- UL 50 GR: E478163
- UL Meter Socket: E520977
- UL 891: E248004
- UL Wire Processing: E523898

Weld Inspection Notes

CWI weld inspection (pre, during, and post) is included in this proposal. MTRs, fabricator letter, fabrication photos, welder certs, and CWI certs will be provided at project completion upon request. NDE testing will be provided if a full penetration weld is performed and the requirement is noted on the drawings. The NDE test method(s) performed will be at the discretion of the CWI (typically Magnetic Particle testing for fillet welds and Ultrasonic testing for full penetration welds) unless the test method is specifically noted on the drawings or requested by the customer.



TESTING & MEASUREMENT

RF Testing

Raycap conducts measurements for its North American products in an RF (radio-frequency) anechoic chamber at its partner's facilities in San Antonio, Texas. Southwest Research Institute (SwRI) and Raycap have a 10+ year testing history, managing demanding testing requirements.

RF propagation through concealment material has been critical for wireless service providers as concealment should not compromise the signal quality and service level. Because of this, Raycap has significantly invested in signal generators, network analyzers, beam forming transmitters, and PIM analyzers. All results are recorded for every material that is considered for concealment solutions. Raycap has also developed RF propagation models based on measurements for several frequency bands and therefore is in a position to define, with details, the RF performance in any spectrum region.

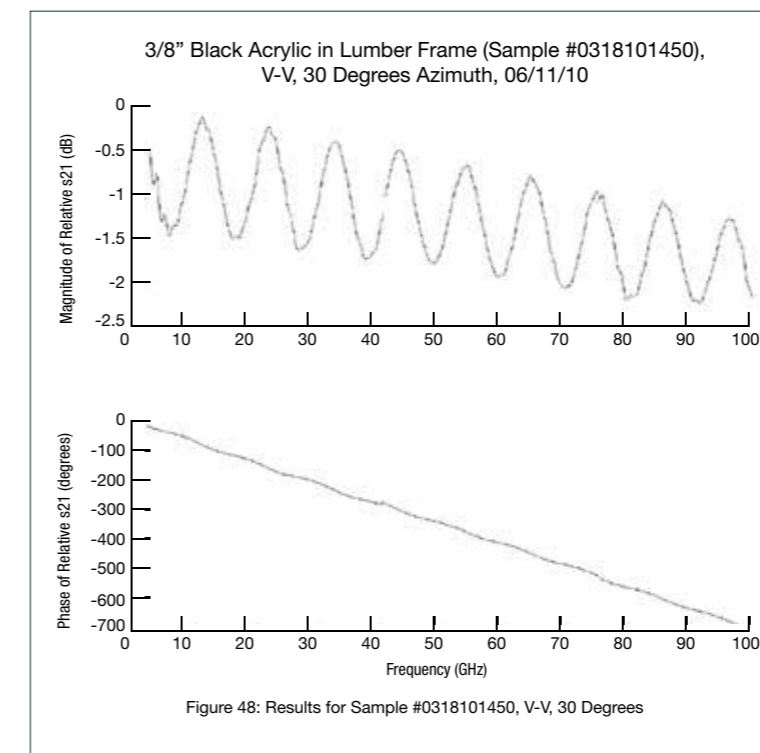
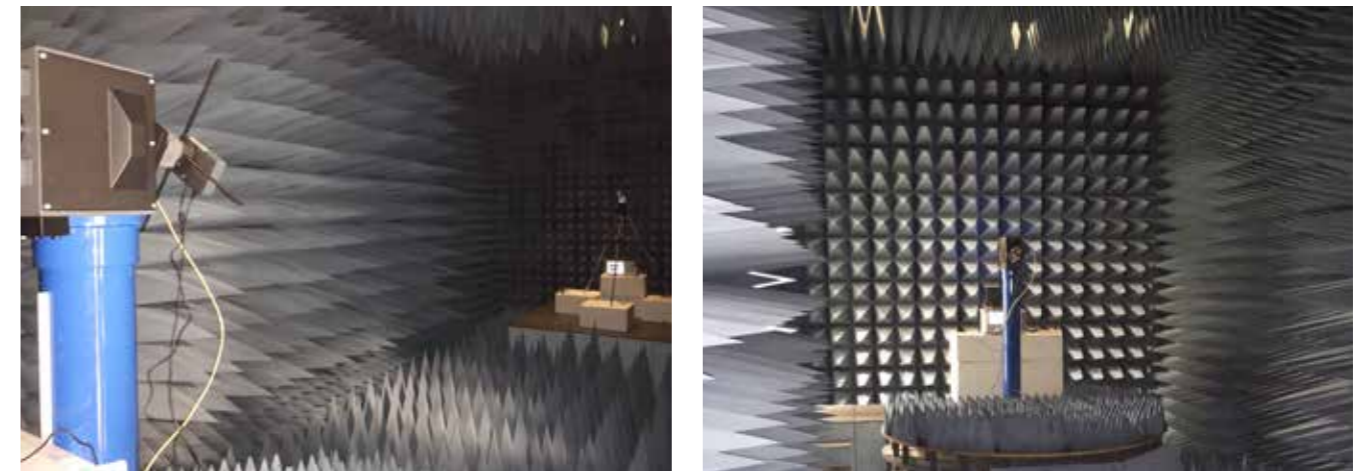

TESTING & MEASUREMENT

PIM Testing

Raycap investigates potential interference issues that its concealment solutions may cause. Therefore, Passive Intermodulation (PIM) testing is performed in Southwest Research Institute's Anechoic RF chamber. The 700MHz LTE and 850MHz Cellular bands are tested using a cellular panel antenna and two PIM Analyzers. Both analyzers are configured to transmit 20 Watts x 2 carriers at the antenna. Each product is centered in the horizontal and vertical main beam of the antenna at a distance of nine feet from the antenna radome.

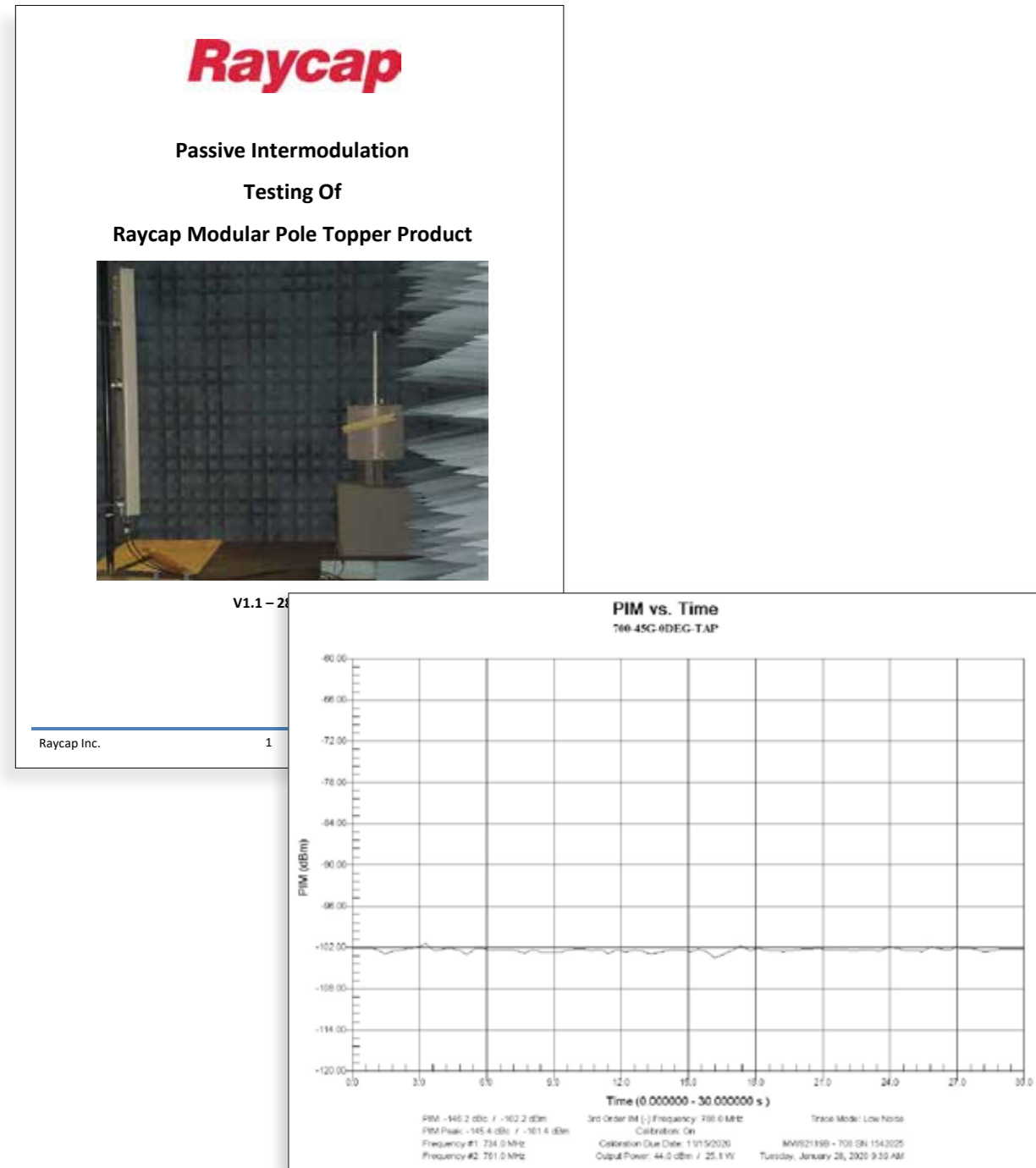

Flammability Testing

Raycap investigates the flammability of material and makes sure its final solutions comply with national and local regulations. Every new material considered for use is tested as per the requirements contained in the below standards:

- UL Standard for Safety for Tests for Flammability of Plastic Materials for Parts in Devices and Appliances;
- UL 94 6th Edition, Dated March 28, 2013 with revisions through May 6, 2021;
- UL 746A 6th Edition, Dated September 6, 2012 with revisions through June 27, 2020.

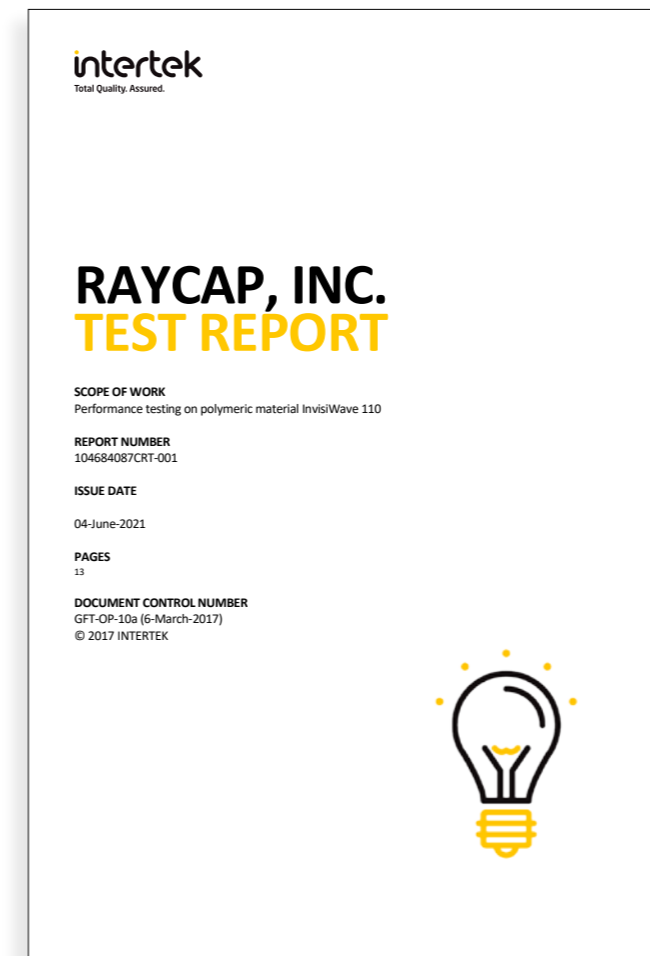

TESTING & MEASUREMENT

InvisiWave LARR Approval



CITY OF LOS ANGELES
CALIFORNIA

BOARD OF BUILDING AND SAFETY COMMISSIONERS

VAN AMBATELOS
PRESIDENT

E. FELICIA BRANNON
VICE PRESIDENT

JOSELYN GEAGA-ROSENTHAL
GEORGE HOVAGUIMIAN
JAVIER NÚÑEZ

ERIC GARCETTI
MAYOR

DEPARTMENT OF BUILDING AND SAFETY
201 NORTH FIGUEROA STREET
LOS ANGELES, CA 90012

FRANK M. BUSH
GENERAL MANAGER
SUPERINTENDENT OF BUILDINGS

OSAMA YOUNAN, P.E.
EXECUTIVE OFFICER

RESEARCH REPORT: RR 25400

Expires: July 1, 2020
Issued Date: June 1, 2019
Code: 2017 LABC

Raycap | STEALTH
7555-A Palmetto Commerce Parkway
North Charleston, SC 29420

Attn: Trey Nemeth
(843) 207-8000 ext 121

GENERAL APPROVAL – Technical Modification - STEALTHCORE FRP Panel Enclosure System and InvisiWave® aperture replacements and radomes for rooftop and Tower-based communication antenna screening.

Raycap | STEALTH
RE: STEALTHCORE FRP Panel Enclosure System and InvisiWave® Aperture Replacements & Radomes

The above products are approved for use with the following conditions:

1. FRP Penetration Beams: The design values for the FRP penetration products are in Table 1.

Property	Direction	Specification
Tensile	Lengthwise	3750 psi
	Crosswise	815 psi
Tensile Modulus	Lengthwise	2.2 x 10 psi
	Crosswise	1.3 x 10 psi
Flexural	Lengthwise	3750 psi
	Crosswise	1250 psi
Flexural Modulus	Lengthwise	1.5 x 10 psi
	Crosswise	0.7 x 10 psi
Compressive Modulus	Lengthwise	5.4 x 10 psi
	Crosswise	2.5 x 10 psi
Shear	Lengthwise - (1)	350 psi
	Lengthwise - (2)	500 psi
	Crosswise - (1)	165 psi
	Crosswise - (2)	215 psi
90° bolt bearing on FRP	Lengthwise	2600 psi
	Crosswise	2450 psi
90° bolt tension	(1)	300 pounds (3)
	(2)	780 pounds (3)
Minimum edge distance		1 - inch

(1) - Load applied perpendicular to lamination.
(2) - Load applied parallel to lamination.
(3) - Load applied with two threads, filled by threaded rod.

consists of pultruded fiberglass and STEALTHCORE between the pultruded shapes and nuts, urethane bonded to the structural panel. Reinforced Plastic form pultrusion Beams are specified: Threaded rod is 0.492 square and 0.692" thick.

Raycap | STEALTH
RE: STEALTHCORE FRP Panel Enclosure System and InvisiWave® Aperture Replacements & Radomes

8. Each panel shall be identified with LARR #25400 and Stealth Logo. FRP structure and panels (before painting) will be color.

9. Screening material shall be located at least 20 ft from interior property lines for Type I, II, III, and IV buildings per 2017 LABC section 1510.6.2, Item 2.

10. Screening material shall be located at least 5 ft from interior property lines for Type V buildings per 2017 LABC section 1510.6.3, Item 3.

11. The fabrication will be in accordance with manufacturer's quality control manual. A copy of the quality control manual is on file with the Engineering Research Section.

12. STEALTH FRP Structural Members and FRP panels can be used for alternate building applications if the structural requirements outlined in this report are met.

Raycap | STEALTH
RE: STEALTHCORE FRP Panel Enclosure System and InvisiWave® Aperture Replacements & Radomes

DISCUSSION

The technical modification is to capture the addition of InvisiWave® product as part of the general approval.

The report is in compliance with the 2017 Los Angeles City Building Code.

The approval is based on tests per section 1510.6 and 2103.2 of the 2017 LABC which show that the approved materials exhibit performance that is equivalent to fire-retarded treated wood.

This general approval will remain effective provided the Report is maintained valid and concurred with the issuing organization. Any revisions to the report must be submitted to this Department for review with appropriate fee to continue the approval of the revised report.

Addressee to whom this Research Report is issued is responsible for providing copies of it, complete with any attachments indicated, to architects, engineers and builders using items approved herein in design or construction which must be approved by Department of Building and Safety Engineers and Inspectors.

DAVID CHANG, P.E.
Engineering Research Section
201 N. Figueroa St., Room 130
Los Angeles, CA 90012
Phone: 213-202-9812
Fax: 213-202-9963

RR 25400
Page 5 of 4

Environmental Testing

Raycap pole coupons and hardware samples are tested to evaluate their resistance to a wide range of temperatures, humidity, weather, climate, and environmental stresses. Testing involves coupon sections of different sizes of poles as well as mounting and attachment hardware. Testing is intended to evaluate the resistance of each component to function-affecting physical damage or degradation from exposure to cyclic temperature and salt fog environments.

TEST REPORT

ENVIRONMENTAL TESTING OF THE
RAYCAP UN-GUYED STEEL CELLULAR
COMMUNICATION POLES COMPONENTS

SwRI Document Number: 18-18292-14-100-FR2
Issue 1
SwRI Project: 18-18292-14-100

Prepared for:
Raycap, Inc.
Concealment Solutions
7555-A Palmetto Commerce Parkway
North Charleston, SC 29420

May 2020

Reviewed By:
Rick Piment
Principal Engineering Technologist,
Structural Dynamics & Product Assurance

Approved By:
Jerry Faren
Manager,
Structural Dynamics & Product Assurance

SwRI Southwest Research Institute®
6220 Culebra Road • Post Office Drawer 28510
San Antonio, Texas 78228-0510



TESTING & MEASUREMENT

Pole Structural Testing

Raycap investigates the structural integrity of its poles. A representative design of a standard nominal diameter is tested to failure. The applied loading is intended to approximate a severe wind event. Testing utilizes guidance from the cantilever method described in ASTM D1036, a standard normally applied to testing wood communications poles. The pole is mounted by the baseplate during testing in the horizontal orientation. A wheeled stand supports the center-of-gravity to provide a primarily unidirectional moment to the base of the pole. The load is applied 475 inches from the base of the pole, three inches from the top. The deflection is recorded at the midpoint and the tip of the pole.



Pole Mounted to Test Fixture (3UN Orientation)



Maximum Deflection (3UN)

**40' x 8" Pole
Destructive Test Report**

Prepared by: Curtis Stimpson
Release: V1.2 5/18/2021

PROPRIETARY AND CONFIDENTIAL

Impact Testing

Raycap pole samples are tested to evaluate their resistance to point impact damage. Testing involves sections of poles approximately five feet in length. Different steel pole sizes are tested, from 8" to 12" diameter. The point of impact testing is performed in accordance with the test methodology described in GR-3159-CORE. Testing is intended to evaluate the resistance of each sample to damage from point impacts, and is evaluated against both the bowling ball impact and a V-edge penetration test. The 100 ft-lb bowling ball impact should not result in any significant denting or deformation resulting in a >10% change in any characteristic dimension. For the V-edge penetration test, the V-edge mandrel is compressed into the pole until a force of 1,000 lbs is reached, and the maximum resulting penetration depth shall be less than 0.25 inch.



TEST REPORT

ENVIRONMENTAL TESTING OF THE
RAYCAP UN-GUYED STEEL CELLULAR
COMMUNICATION POLES COMPONENTS

SwRI Document Number: 18-18292-14-100-PR2
Issue 1
SwRI Project 18-18292-14-100

Prepared for:
Raycap, Inc.
Concealment Solutions
7155-A Palmetto Commerce Parkway
North Charleston, SC 29420

May 2020

Reviewed By: Rick Pittman
Principal Engineering Technologist,
Structural Dynamics & Product Assurance

Approved By: Jonny Faren
Manager,
Structural Dynamics & Product Assurance

The results of this test report apply only to the specific specimen tested. If the manufacturer utilizes the test results to make any other portion of the same model, or for the same or similar, the manufacturer should request the additional services and procedures with specific methods and materials components. This test report does not constitute a warranty or any other form of assurance of Southwest Research Institute.

Southwest Research Institute®
6220 Cadellia Road • Post Office Drawer 28510
San Antonio, Texas 78228-0010

TESTING & MEASUREMENT

Electrical Safety

Raycap is the only supplier to certify its concealment poles per UL. The luminaire pole houses a proprietary load distribution center capable of providing up to 12 branch circuits at 120VAC, or 6 branch circuits at 240VAC. This distribution equipment is also certified to UL 67 Panelboards (E479137) and meets Suitable for Service Equipment (SuSE) requirements.

As part of the production line testing required under UL 1598, both a Bonding Circuit Impedance test and a Dielectric Voltage-Withstand test are taken.

Raycap recently completed all the necessary testing as per UL 1598 Standard for Safety. The relevant certificate of compliance follows.



With more than 30+ years of experience creating innovative infrastructure solutions, Raycap knows how to create superior products that customers rely upon to ensure the integrity of their networks. With the acquisition of STEALTH in 2018, we gained 25+ years of experience in the concealment industry. Together, this combined expertise enables us to best help customers as they build out their small cell infrastructure and ultrafast 5G networks.

The new networks will use both C-band and 5G mmWave radios (sub-6GHz, 24GHz, 28GHz and 39GHz) and their associated MIMO beam forming antenna systems, and require a dense network of many thousands more sites than exist in the present day infrastructure. Concealing these added nodes had previously been a challenge because the use of some concealment materials had interfered with 5G performance. Not so anymore.

Raycap engineered InvisiWave, a patent-pending breakthrough, tested, concealment material that effectively conceals 5G mmWave and C-Band sites with practically zero interference. InvisiWave provides a way forward for carriers and municipalities who need to balance the demand for signal performance with aesthetic requirements at the street level. Available in many different concealment configurations, InvisiWave products will help customers take their 5G C-band and mmWave projects where they need to go.

Features:

- Rigid surface
- Paint adhesion
- UV Resistant
- Hydrophobic surface
- Easy to fabricate and create in various form factors
- Chemical and fire resistance (UL 94, EN13501)
- Tested from 700MHz to 100GHz
- Thermal insulation
- Patent pending
- Minimum insertion loss (avg. 0.1 dB @ sub-6GHz, 0° angle of incidence)
- (avg. 0.1 dB @ 28GHz, 0° angle of incidence)
- (avg. 0.2 dB @ 24GHz, 0° angle of incidence)
- (avg. 0.4 dB @ 39GHz, 0° angle of incidence)
- Thoroughly tested to identify beam forming impact
- Compatible to back lobe mitigation techniques
- Class 'A' Fire Rated
- City of Los Angeles Approved (Dept. of Building & Safety LARR 25400)

Panel & Rooftop Products

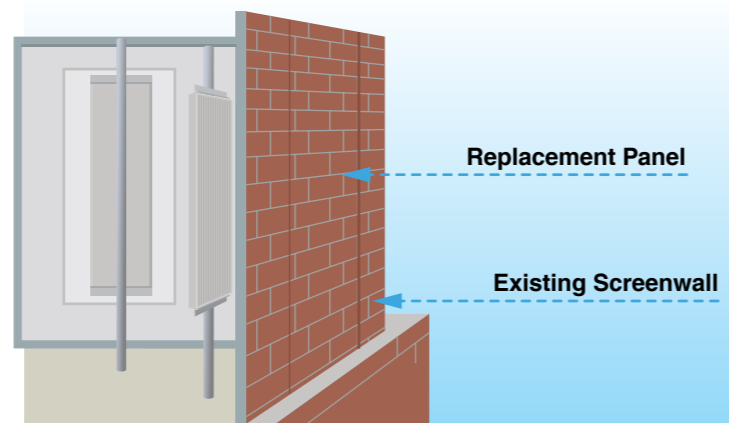

Pole Top Shrouds



InvisiWave for New Site Builds & Retrofit Projects

Raycap's InvisiWave panels offer site operators the option of ordering new or replacement panels to build a new, or retrofit an existing installation. Rain hoods and radio mounting kits can also be ordered.





SERVICES

PRODUCT DESIGN

Raycap's global Research & Development (R&D) operation merges best-in-class facilities with some of the best engineering talent in the world. Raycap employs more than 125 engineers worldwide, providing design services for the company's diverse customer base. Capabilities include structural, electrical, RF, chemical, mechanical, electronic, and specialized telecom disciplines such as network architecture, fiber optics, RF, signal testing and PIM interference. Raycap's dedication to innovation is evident, and the engineering teams are driven to achieve excellence in everything they do.

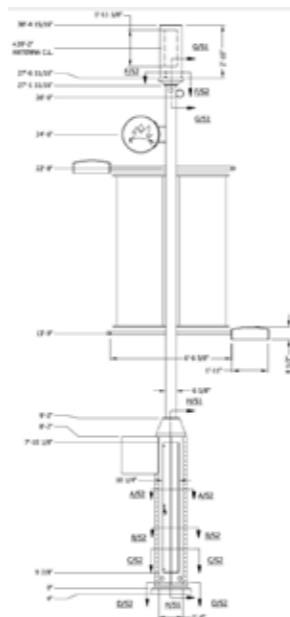

INTEGRATION

Our broad experience in integration services enables us to help our customers by manufacturing a fully or partially integrated concealed small cell pole product.

Raycap's integrated small cell poles arrive at a site location, with cabling, radios, and power/fiber equipment pre-installed and pre-tested. Fully integrated small cell poles can significantly reduce the time spent on installation. The pole needs to be set on the foundation and the power and fiber lines connected. Taking advantage of Raycap's expertise in integration saves our customers time and money.

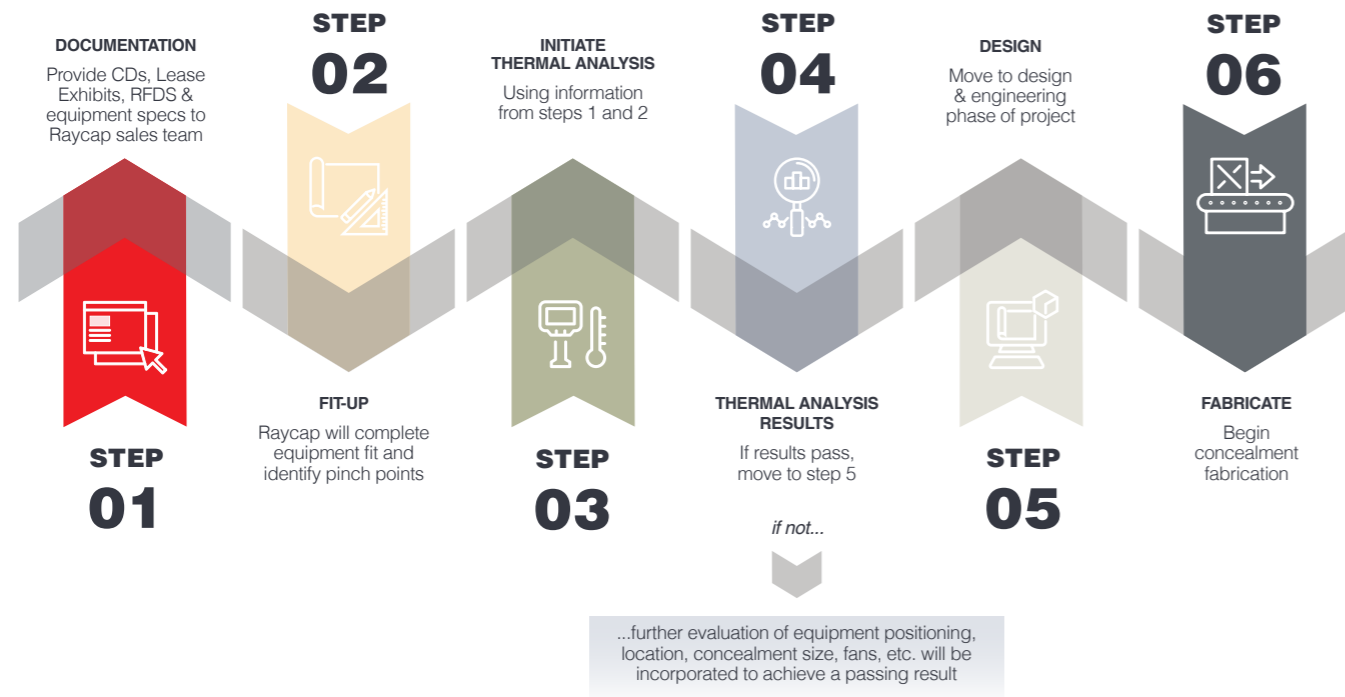

PHOTO SIMULATIONS

A picture is worth a thousand words, and when only a photo rendering of what a product will look like in a particular environment will do, Raycap is there to help its customers visualize. Our graphic designers have the creative and technical ability to support your sales teams' requests for photo simulations, whether in a particular location or an imagined environment. We understand that the customer always comes first and that through these efforts, our customers can help their customers get projects through the many hurdles that can come with getting a small cell project approved.



THERMAL ANALYSIS



SMART ACTIVE COOLING

RCP 4770 IP

Fan control units are designed to be mounted in telecom poles and can control as many as 15 AC fans located in various thermal zones. In addition, they monitor and alert on the state of the fan operation, alarming if malfunctioning occurs. These units are UL Listed for information technology equipment in wet and humid locations.

Features Include:

- Can control up to 15 fans based on ambient and monitored temperatures in thermally sensitive zones of a pole installation
- Variable AC fan speed – Speed of fan varied based on internal thermal sensor and optional external sensors (up to 3)
- Dry Contact Alarms
- Locked fan
- Fan disconnected
- External temperature sensor shorted or open
- Power outage
- Suitable for wet-rated environment



SITE VISITS & SURVEYS

By aiding our customers with site visits and surveys, Raycap offers seasoned perspectives with invaluable knowledge and resources for our customers. We can provide assistance about what has worked and provide new visionary concepts about what concealments could work in the future. Our strength is in our knowledge of materials and our many years of field test results.



STRUCTURAL ANALYSIS

Raycap designs in accordance with the 2015 International Building Code and the ANSI/TIA-222-G "Structural Standard for Antenna Supporting Structures and Antennas." Additionally, all steel members and connections are designed to meet the AISC Steel Construction Manual requirements.

An indicative set of criteria follows:

- Ultimate windspeed (V): 171 mph (3-sec gust) per the ASCE 7-10
- Ice: 0" radial ice (nominal) with 30 mph wind (3-sec gust)
- Basic windspeed of 60 mph (3-sec gust) for the service condition (deflection limitation only)
- Structure Class II, Exposure C, Topographic Category 1 with crest height of 0 ft (The criteria depend on local requirements and may vary.)

APPENDIX: RAL STANDARD COLOR SELECTION

APPENDIX

RAL #	Satin SKU	Color Name
1001	RHS3-00004	Beige
1003	RYS3-00001	Signal Yellow
1013	RHS3-00001	Oyster White
1018	RYS3-00003	Zinc Yellow
1019	RHS3-00005	Grey Beige
1023	RYS3-60010	Traffic Yellow
1028	RYS3-60013	Melon Yellow
1037	RYS3-60006	Sun Yellow
2003	RES3-00001	Pastel Orange
2004	RES3-20003	Pure Orange
2010	RES3-20004	Signal Orange
3000	RRS3-20009	Flame Red
3001	RRS3-00001	Signal Red
3002	RRS3-00004	Carmine Red
3003	RRS3-00003	Ruby Red
3004	RRS3-00007	Purple Red
3005	RRS3-60002	Wine Red
3020	RRS3-20010	Traffic Red
4005	RRS3-20005	Blue Lilac
5002	RLS3-20001	Ultramarine Blue
5003	RLS3-20003	Sapphire Blue
5005	RLS3-20007	Signal Blue
5010	RLS3-20008	Gentian Blue
5011	RLS3-20010	Steel Blue
5012	RLS3-20009	Light Blue
5013	RLS3-20011	Cobalt Blue
5015	RLS3-20013	Sky Blue
5017	RLS3-90001	Traffic Blue
5019	RLS3-20015	Capri Blue
5022	RLS3-60001-C25	Night Blue
5024	RLS3-60003	Pastel Blue
6005	RGS3-80002	Moss Green
6009	RGS3-00025	Fir Green
6012	RGS3-00003	Black Green
6016	RGS3-00001	Turquoise Green
6018	RGS3-00021	Yellow Green
6027	RGS3-00015	Light Green
6029	RGS3-60012	Mint Green
7001	RAS3-00014	Silver Grey

RAL #	Satin SKU	Color Name
7004	RAS3-20001	Signal Grey
7006	RHS3-00006	Beige Grey
7011	RAS3-00018	Iron Grey
7012	RAS3-20002	Basalt Grey
7013	RGS3-00008	Brown Grey
7016	RAS3-00005	Anthracite Grey
7021	RBS3-00002	Black Grey
7022	RNS3-20001	Umbra Grey
7023	RGS3-00011	Concrete Grey
7024	RAS3-20004	Graphite Grey
7030	RAS3-00007	Stone Grey
7032	RHS3-20002	Pebble Grey
7035	RAS3-00030	Light Grey
7037	RAS3-00020	Dusty Grey
7038	RAS3-00010	Agate Grey
7040	RAS3-00025	Window Grey
7042	RAS3-00003	Traffic Grey A
7043	RAS3-00019	Traffic Grey B
7044	RAS3-00027	Silk Grey
7045	RAS3-00024	Telegrey 1
7046	RAS3-00023	Telegrey 2
7047	RAS3-40005	Telegrey 4
8008	RNS3-20008	Olive Brown
8011	RNS3-20002	Nut Brown
8014	RNS3-00002	Sepia Brown
8016	RNS3-00012	Mahogany Brown
8017	RNS3-00011	Chocolate Brown
8019	RNS3-00004	Grey Brown
8025	RNS3-20011	Pale Brown
8028	RNS3-20012	Terra Brown
9001	RWS3-60004	Cream
9002	RWS3-60002	Grey White
9003	RWS3-00002	Signal White
9005	RBS3-60004	Jet Black
9010	RWS3-60003	Pure White
9011	RBS3-60001	Graphite Black
9016	RWS3-60001	Traffic White
9017	RBS3-60002	Traffic Black

RAYCAP WORLDWIDE LOCATIONS

Raycap Inc.
806 South Clearwater Loop
Post Falls, ID 83854
United States of America

7555-A Palmetto Commerce Pkwy
North Charleston, SC 29420
United States of America

46 Sellers Street
Kearny, NJ 07032
United States of America

Raycap GmbH
Parkring 11
85748 Garching Munich
Germany

Raycap S.A.
Telou & Petroutsou 14
15124 Maroussi Athens
Greece

Raycap S.A. Manufacturing
Industrial Area of Drama
66100 Drama
Greece

Raycap d.o.o.
Poslovna cona Žeje pri Komendi
Pod hrasti 7
1218 Komenda
Slovenia

Raycap Cyprus Ltd.
46 Lefkosias Street
Industrial Area of Dali
2540 Nicosia
Cyprus

Raycap SAS
84 rue Charles Michels
Building B
93200 Saint-Denis
France

Raycap Corporation SRL
102, Barbu Vacarescu
entrance D, 4th floor, D22,
020283 Bucharest
Romania

Raycap (Suzhou) Co. Ltd.
Block B, Phase II
of New Sea Union
No. 58 Heshun Road
SIP, Suzhou 215122
Jiangsu Province
China



Raycap

raycap.com • info@raycap.com

Products in this guide are examples of our offerings.
Please contact us for custom solutions.

InvisiWave, STEALTH and Strikesorb are registered trademarks of Raycap.
© 2024 Raycap All rights reserved.
G09-00-214 240417